

SHARP®

BD-HP20U

BLU-RAY DISC PLAYER
LECTEUR DE DISQUE BLU-RAY
REPRODUCTOR DE DISCOS BLU-RAY

OPERATION MANUAL
MODE D'EMPLOI
MANUAL DE OPERACIÓN

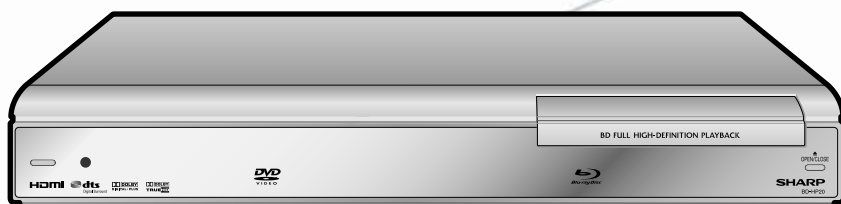

ENGLISH

FRANÇAIS

ESPAÑOL

AQUOS LINK



BD-Video



RW COMPATIBLE



HDMI™
HIGH-DEFINITION MULTIMEDIA INTERFACE



OPERATION MANUAL

ENGLISH

For future reference, record the model and serial number (located on the rear of the product) in the space provided.

Model No.: _____

Serial No.: _____

WARNING: TO REDUCE THE RISK OF FIRE OR ELECTRIC SHOCK, DO NOT EXPOSE THIS APPLIANCE TO RAIN OR MOISTURE.



CAUTION
RISK OF ELECTRIC SHOCK
DO NOT OPEN



CAUTION:
TO REDUCE THE RISK OF ELECTRIC SHOCK, DO NOT REMOVE COVER. NO USER-SERVICEABLE PARTS INSIDE. REFER SERVICING TO QUALIFIED SERVICE PERSONNEL.



This symbol warns the user of uninsulated voltage within the unit that can cause dangerous electric shocks.



This symbol alerts the user that there are important operating and maintenance instructions in the literature accompanying this unit.

“WARNING—FCC Regulations state that any unauthorized changes or modifications to this equipment not expressly approved by the manufacturer could void the user’s authority to operate this equipment.”

INFORMATION

This equipment has been tested and found to comply with the limits for a Class B digital device, pursuant to Part 15 of the FCC Rules. These limits are designed to provide reasonable protection against harmful interference in a residential installation. This equipment generates, uses and can radiate radio frequency energy and, if not installed and used in accordance with the instructions, may cause harmful interference to radio communications. However, there is no guarantee that interference will not occur in a particular installation. If this equipment does cause harmful interference to radio or television reception, which can be determined by turning the equipment off and on, the user is encouraged to try to correct the interference by one or more of the following measures:

- Reorient or relocate the receiving antenna.
- Increase the separation between the equipment and receiver.
- Connect the equipment into an outlet on a circuit different from that to which the receiver is connected.
- Consult the dealer or an experienced radio/TV technician for help.

CAUTION:

THIS UNIT IS A CLASS 1 LASER PRODUCT.

USE OF CONTROLS OR ADJUSTMENTS OR PERFORMANCE OF PROCEDURES OTHER THAN THOSE SPECIFIED HEREIN MAY RESULT IN HAZARDOUS RADIATION EXPOSURE.

AS THE LASER BEAM USED IN THIS UNIT IS HARMFUL TO THE EYES, DO NOT ATTEMPT TO DISASSEMBLE THE CABINET.
REFER SERVICING TO QUALIFIED PERSONNEL ONLY.

DEAR SHARP CUSTOMER

Thank you for your purchase of the Sharp Blu-ray Disc Player. To ensure safety and many years of trouble-free operation of your product, please read the Important Safety Instructions carefully before using this product.

IMPORTANT SAFETY INSTRUCTIONS

Electricity is used to perform many useful functions, but it can also cause personal injuries and property damage if improperly handled. This product has been engineered and manufactured with the highest priority on safety. However, improper use can result in electric shock and/or fire. In order to prevent potential danger, please observe the following instructions when installing, operating and cleaning the product. To ensure your safety and prolong the service life of your Blu-ray Disc Player, please read the following precautions carefully before using the product.

- 1) Read these instructions.
- 2) Keep these instructions.
- 3) Heed all warnings.
- 4) Follow all instructions.
- 5) Do not use this apparatus near water.
- 6) Clean only with dry cloth.
- 7) Do not block any ventilation openings. Install in accordance with the manufacturer's instructions.
- 8) Do not install near any heat sources such as radiators, heat registers, stoves, or other apparatus (including amplifiers) that produce heat.
- 9) Do not defeat the safety purpose of the polarized or grounding-type plug. A polarized plug has two blades with one wider than the other. A grounding type plug has two blades and a third grounding prong. The wide blade or the third prong are provided for your safety. If the provided plug does not fit into your outlet, consult an electrician for replacement of the obsolete outlet.
- 10) Protect the power cord from being walked on or pinched particularly at plugs, convenience receptacles, and the point where they exit from the apparatus.
- 11) Only use attachments/accessories specified by the manufacturer.
- 12) Use only with the cart, stand, tripod, bracket, or table specified by the manufacturer, or sold with the apparatus. When a cart is used, use caution when moving the cart/apparatus combination to avoid injury from tip-over.
- 13) Unplug this apparatus during lightning storms or when unused for long periods of time.
- 14) Refer all servicing to qualified service personnel. Servicing is required when the apparatus has been damaged in any way, such as power-supply cord or plug is damaged, liquid has been spilled or objects have fallen into the apparatus, the apparatus has been exposed to rain or moisture, does not operate normally, or has been dropped.



Additional Safety Information

- 15) Power Sources—This product should be operated only from the type of power source indicated on the marking label. If you are not sure of the type of power supply to your home, consult your product dealer or local power company. For products intended to operate from battery power, or other sources, refer to the operating instructions.
- 16) Overloading—Do not overload wall outlets, extension cords, or integral convenience receptacles as this can result in a risk of fire or electric shock.
- 17) Object and Liquid Entry—Never push objects of any kind into this product through openings as they may touch dangerous voltage points or short-out parts that could result in a fire or electric shock. Never spill liquid of any kind on the product.
- 18) Damage Requiring Service—Unplug this product from the wall outlet and refer servicing to qualified service personnel under the following conditions:
 - a) When the AC cord or plug is damaged,
 - b) If liquid has been spilled, or objects have fallen into the product,
 - c) If the product has been exposed to rain or water,
 - d) If the product does not operate normally by following the operating instructions.
Adjust only those controls that are covered by the operating instructions as an improper adjustment of other controls may result in damage and will often require extensive work by a qualified technician to restore the product to its normal operation,
 - e) If the product has been dropped or damaged in any way, and
 - f) When the product exhibits a distinct change in performance - this indicates a need for service.
- 19) Replacement Parts—When replacement parts are required, be sure the service technician has used replacement parts specified by the manufacturer or have the same characteristics as the original part. Unauthorized substitutions may result in fire, electric shock, or other hazards.
- 20) Safety Check—Upon completion of any service or repairs to this product, ask the service technician to perform safety checks to determine that the product is in proper operating condition.
- 21) Wall or ceiling mounting—When mounting the product on a wall or ceiling, be sure to install the product according to the method recommended by the manufacturer.
- 22) The mains plug is used as disconnect device and shall always remain readily operable.

IMPORTANT SAFETY INSTRUCTIONS

- Water and Moisture — Do not use this product near water - for example, near a bath tub, wash bowl, kitchen sink, or laundry tub; in a wet basement; or near a swimming pool; and the like.

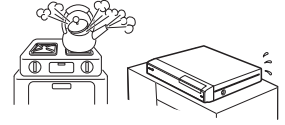

- Stand — Do not place the product on an unstable cart, stand, tripod or table. Placing the product on an unstable base can cause the product to fall, resulting in serious personal injuries as well as damage to the product. Use only a cart, stand, tripod, bracket or table recommended by the manufacturer or sold with the product. When mounting the product on a wall, be sure to follow the manufacturer's instructions. Use only the mounting hardware recommended by the manufacturer.

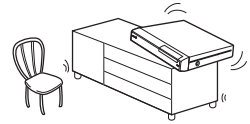

- Selecting the location — Select a place with no direct sunlight and good ventilation.

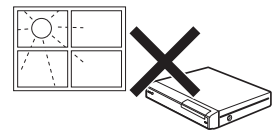

- Ventilation — The vents and other openings in the cabinet are designed for ventilation. Do not cover or block these vents and openings since insufficient ventilation can cause overheating and/or shorten the life of the product. Do not place the product on a bed, sofa, rug or other similar surface, since they can block ventilation openings. This product is not designed for built-in installation; do not place the product in an enclosed place such as a bookcase or rack, unless proper ventilation is provided or the manufacturer's instructions are followed.

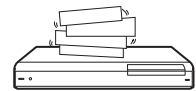

- Heat — The product should be situated away from heat sources such as radiators, heat registers, stoves, or other products (including amplifiers) that produce heat.

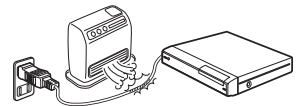

- Lightning — For added protection for this television equipment during a lightning storm, or when it is left unattended and unused for long periods of time, unplug it from the wall outlet and disconnect the antenna. This will prevent damage to the equipment due to lightning and power-line surges.

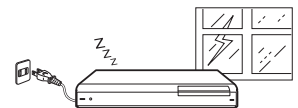

- To prevent fire, never place any type of candle or flames on the top or near the product.

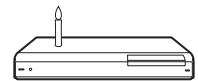

- To prevent fire or shock hazard, do not expose this product to dripping or splashing. No objects filled with liquids, such as vases, should be placed on the product.

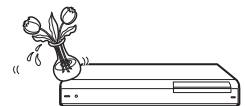

IMPORTANT SAFETY INSTRUCTIONS

- To prevent fire or shock hazard, do not place the AC cord under the product or other heavy items.

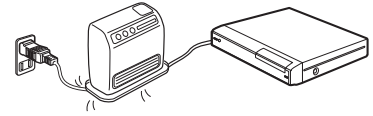

- Turn off the main power and unplug the AC cord from the wall outlet before handling.
- To clean the outer cabinet, periodically wipe it with a soft cloth.
- Do not use chemicals for cleaning. It may damage the cabinet finish.



1

Introduction

Contents

1 Introduction

DEAR SHARP CUSTOMER	1
IMPORTANT SAFETY INSTRUCTIONS	1
Contents	4
What would you like to do with this Player?	5
About Discs	6 – 7
About Disc Contents	8
Important Information	9
Getting Started	10
Major Components	11 – 12

2 Connection

Introduction to Connections	13
Video Connections	14 – 16
Connecting to the HDMI Terminal	14
Change the video output to HDMI video out	14
Connecting to the Component Jacks	15
Connecting to the S-video or Video Jack	16
Audio Connections	17 – 19
Connecting 5.1 ch Speakers through an Amplifier ..	17
Connecting to the Digital Audio Terminal or Jack	18
Connecting the Audio Jacks	19

3 Disc Playback

Before Starting Playback	20 – 23
Loading the Batteries in the Remote Control	20
Connecting the Power Cord	20
Setting the Remote Control Code	21
Operating a SHARP TV Using the Remote Control ...	21
Turning the Power On	22
Language Setting	22
Turning Off the LCD Backlight and Indications	23
Using AQUOS LINK	23
BD/DVD/CD Playback	24 – 27
Loading a Disc	24
BD/DVD Video Playback	24
BD/DVD Menus	25
BD-R/-RE/DVD-R/-RW Playback	26 – 27
Audio CD Playback	27
Playback Functions	28 – 30
Fast Forward/Reverse (Search)	28
Skipping to the Next or the Start of the Current Chapter (Track)	28
Slow Playback	28
Pause/Frame Advance Playback	28
Skip Search	28
Replay	28

Repeat Playback of a Title or Chapter (Repeat Playback)	28
Enlarge the playback image (Zoom function)	28
Partial Repeat Playback (Repeat Playback of a Specified Part)	29
Switching Audio	29
Switching Subtitles	29
Switching the Angle	30
Displaying the Angle Mark	30
Settings During Playback	31 – 32
Function Control	31 – 32

4 Settings

SETTINGS	33 – 46
AUDIO VIDEO SETTINGS	33 – 35
Basic Operation for AUDIO VIDEO SETTINGS	36
SPEAKER SETTINGS	37
Basic Operation for SPEAKER SETTINGS	37 – 39
QUICK START	40
AUTO POWER OFF	40
AQUOS LINK	40
PLAYBACK	41 – 42
Basic Operation for PLAYBACK SETTING	43
FRONT DISPLAY/LED	44
VERSION	44
SYSTEM RESET	44
SOFTWARE UPDATE	45 – 46

5 Appendix

Troubleshooting	47 – 48
On-screen Error Messages	49
Glossary	50 – 51
Specifications	52
LIMITED WARRANTY	53 – 54

* The illustrations and on-screen displays in this operation manual are for explanation purposes and may vary slightly from the actual operations.

What would you like to do with this Player?

Watching high quality movies on Blu-ray discs

This Player offers full high-definition Blu-ray disc playback.

BD/DVD Video Playback (p. 24)

Enjoying different kinds of discs and contents

Use this Player to enjoy various types of optical discs such as DVDs and CDs that contain various multimedia content.

About Discs (pp. 6-7)
BD/DVD Video Playback (p. 24)

Simple connection and operation through HDMI

This Player is equipped with an HDMI terminal. You can connect it to the TV using HDMI and no other cable will be needed to enjoy movies. If your TV is compatible with AQUOS LINK, you can control both the TV and this Player with simple operations.

Introduction to Connections (p. 13)
Video Connections (p. 14)

Experiencing surround sound with your speakers

This Player can output 5.1 ch surround sound to the speakers through an amplifier. Enjoy the rich feel of a movie theater.

Introduction to Connections (p. 13)
Audio Connections (p. 17)

What to do first:

Refer to “Getting Started” (p. 10) to prepare for watching your discs.

1 Introduction (pp. 1-12)

Explains the important operation information.

2 Connection (pp. 13-19)

Shows the connecting options provided by this Player.

3 Disc Playback (pp. 20-32)

Shows simple playback and useful functions.

4 Settings (pp. 33-46)

Gives you more options to suit your circumstances.

5 Appendix (pp. 47-54)

Provides troubleshooting tips and more information.

About Discs

A Quick Reference for Selecting Discs

The following is a quick reference to see what discs can/cannot be used with this Player. Each disc has a compatible Recording Format(s) which may present some constraints. For detailed and exact information, read the explanation in pages 6 and 7.

■ Can Play Back

- BD Video (with Region code "A" and "ALL" only)
- BD-RE Ver.2.1 1L (finalized disc only)
- BD-R Ver.1.1 1L (*finalized disc only)
- DVD Video (with Region code "1" and "ALL" only)
- DVD-RW/DVD-R (*finalized disc only)
- DVD+RW/DVD+R (*finalized disc only)
- DVD-R DL (*finalized disc only)
- Audio CD
- CD-RW/CD-R

■ Cannot Play Back

- CDG, Video CD, Photo CD, CD-ROM, CD-TEXT, SVCD, SACD, PD, CDV, CVD, DVD-RAM, DVD-Audio
- BD-RE Ver. 1.0, BD-RE DL, CD-MP3, CD-WMA

NOTE

* "Finalize" in this manual refers to making sure to have a recording device process on the recorded disc so that it will play in other DVD players as well as this player. Only finalized discs will playback in this player.



Blu-ray Disc

Blu-ray Disc is the ultimate next generation optical media format, offering the following key features:

- Largest capacity (25 GB single layer – 50 GB dual layer) – with over 5 times the amount of content possible with current DVDs, particularly well suited for high definition feature films with extended levels of interactive features
- Pristine picture quality with the capability for full high definition 1920 x 1080p resolution
- Best audio possible with uncompressed surround sound (higher quality than even theatre audio)
- Broadest industry support – ensuring more choice for consumers in the marketplace
- Hardware products will be backward compatible with DVDs, allowing continued enjoyment of existing DVD libraries
- Disc Durability – new breakthroughs in hard coating technologies gives Blu-ray Discs the strongest resistance to scratches and finger prints.

Types of Discs that Can Be Used with This Player

- The following discs can be played back in this Player. Do not use an 8 cm (3") to 12 cm (5") adapter.
- Use discs that conform to compatible standards as indicated by the presence of official logos on the disc label. Playback of discs not complying with these standards are not guaranteed. In addition, the image quality or sound quality is not guaranteed even if the discs can be played back.

Disc Type		Recording Format	Contents	Disc Size
BD video	Region code A/ALL 	—	Audio + Video (Movie)	12 cm (5")
BD-RE/BD-R (finalized disc only)				
DVD Video	Region code 	Video/VR mode	Audio + Video (Movie)	12 cm (5") 8 cm (3")
DVD+RW/DVD+R DVD-RW/DVD-R DVD-R DL		Video/VR mode (finalized disc only)	Audio + Video (Movie)	12 cm (5") 8 cm (5")
Audio CD *1		Audio CD (CD-DA)	Audio	12 cm (5") 8 cm (3")
CD-RW/CD-R (finalized disc only)		Audio CD (CD-DA)	Audio	

*1 This Player has been designed on the premise of playing back Audio CDs that comply with CD (Compact Disc) standards. CDs containing a signal for the purpose of protecting copyrights (copy control signal) may not be able to be played back with this Player.

- BD/DVD video players and discs have region codes, which dictate the regions in which a disc can be played. This Player's region code is **A** for BD and **1** for DVD. (Discs marked **ALL** will play in any player.)
- BD/DVD Video operations and functions may be different from the explanations in this manual and some operations may be prohibited due to disc manufacturer's settings.
- If a menu screen or operating instructions are displayed during playback of a disc, follow the operating procedure displayed.
- The audio component of a DVD video recorded at 96 kHz (Linear PCM) will be output as 48 kHz audio during playback.

NOTE

- Playback for some of the discs in the tables above may not be possible depending on the disc.
- * "Finalize" in this manual refers to making sure to have a recording device process the recorded disc so that it will play in other DVD players and on this player. Accordingly, only finalized discs will playback in this player.

About Discs

Discs that Cannot Be Used with This Player

- **The following discs cannot be played back or will not play back properly on this Player. If such a disc is mistakenly played back, speaker damage may occur. Never attempt to play back these discs.**

CDG, Video CD, Photo CD, CD-ROM, CD-TEXT, SVCD, SACD, PD, CDV, CVD, DVD-RAM, DVD-Audio
BD-RE Ver. 1.0, BD-RE DL, CD-MP3, CD-WMA

- **Discs with unusual shapes cannot be played.**
 - Discs with unusual shapes (heart-shaped or hexagonal discs, etc.) cannot be used. The use of such discs will cause malfunction.
- **The following BD video discs cannot be played.**
 - Discs not displaying "A" or "ALL" for the region code (discs sold outside the authorized marketing area).^{*2}
 - Discs produced illegally.
 - Discs recorded for commercial use.

^{*2} The region code for this product is A.
- **The following DVD video discs cannot be played.**
 - Discs not displaying "1" or "ALL" for the region code (discs sold outside the authorized marketing area).^{*3}
 - Discs produced illegally.
 - Discs recorded for commercial use.

^{*3} The region code for this product is 1.
- **The following BD-RE/R, DVD-RW/R, DVD+RW/R discs cannot be played.**
 - Discs on which data has not been recorded cannot be played back.
- **The following Audio CD discs cannot be played.**
 - Discs containing a signal for the purpose of protecting copyrights (copy control signal) may not be played back with this Player.
 - This Player has been designed on the premise of playing back Audio CDs that comply with CD (Compact Disc) standards.
- **The following CD-RW/R discs cannot be played.**
 - Discs on which data has not been recorded cannot be played back.
 - Non-finalized discs cannot be played back.
 - Discs recorded in a format other than an Audio CD cannot be played back.
 - Discs may not be played back depending on their recording status or the status of the disc itself.
 - Discs may not be played back depending on their compatibility with this Player.

About Disc Contents

Title, Chapter and Track

- Blu-ray discs and DVDs are divided into “Titles” and “Chapters”. If the disc has more than one movie on it, each movie would be a separate “Title”. “Chapters”, on the other hand, are subdivisions of titles. (See Example 1.)
- Audio CDs are divided into “Tracks”. You can think of a “Track” as one tune on an Audio CD. (See Example 2.)

Example 1: Blu-ray disc or DVD

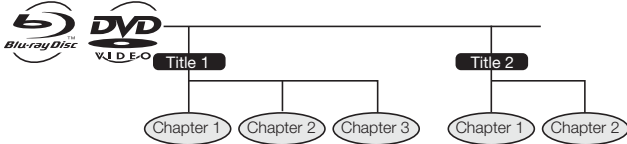

Example 2: Audio CD



Icons Used on DVD Video Disc Cases

The back of the case of a DVD that is commercially available usually contains various information about the contents of the disc.

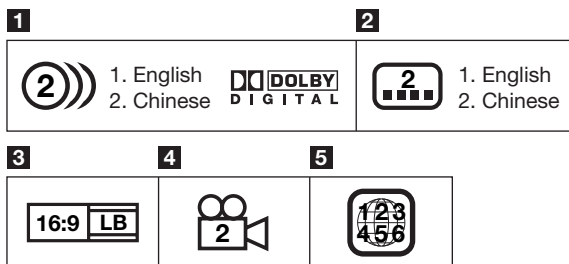

1 Audio tracks and audio formats

DVD discs can contain up to 8 separate tracks with a different language on each. The first in the list is the original track.

This section also details the audio format of each soundtrack—Dolby Digital, DTS, MPEG etc.

Dolby Digital

A sound system developed by Dolby Laboratories Inc. that gives movie theater ambience to audio output when the Player is connected to a Dolby Digital processor or amplifier.

DTS

DTS is a digital sound system developed by DTS, Inc. for use in cinemas. This system uses 6 audio channels and provides accurate sound field positioning and realistic acoustics. (By connecting a DTS Digital Surround decoder, you can also listen to DTS Digital Surround sound.)

Linear PCM

Linear PCM is a signal recording format used for Audio CDs and on some DVD and Blu-ray discs. The sound on Audio CDs is recorded at 44.1 kHz with 16 bits. (Sound is recorded between 48 kHz with 16 bits and 96 kHz with 24 bits on DVD video discs and between 48 kHz with 16 bits and 192 kHz with 24 bits on BD video discs.)

MPEG

MPEG Audio gives movie theater ambience to audio output when the Player is connected to an MPEG Audio 5.1 channel processor or amplifier.

NOTE

- This Player supports 2-channel (L/R) audio and 5.1 ch (Multi-channel) MPEG Audio 1/2 (only when the DIGITAL AUDIO OUT OPTICAL/COAXIAL jack is used for connection). It does not support 7.1 channel MPEG Audio Ver.2.0.

2 Subtitle languages

This indicates the kind of subtitles.

3 Screen aspect ratio

Movies are shot in a variety of screen modes.

4 Camera angle

Recorded onto some BD/DVD discs are scenes which have been simultaneously shot from a number of different angles (the same scene is shot from the front, from the left side, from the right side, etc.).

5 Region code

This indicates the region code (playable region code).

The Icons Used in This Operation Manual

- BD VIDEO** Indicates the functions that can be performed for BD Video discs.
- BD-RE** Indicates the functions that can be performed for BD-RE discs.
- BD-R** Indicates the functions that can be performed for BD-R discs.
- DVD VIDEO** Indicates the functions that can be performed for DVD Video discs.
- DVD-RW** Indicates the functions that can be performed for DVD-RW discs.
- DVD-R** Indicates the functions that can be performed for DVD-R discs.
- AUDIO CD** Indicates the functions that can be performed for Audio CDs.





Important Information

Disc Precautions

Be Careful of Scratches and Dust

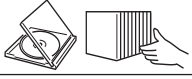
- BD, DVD and CD discs are sensitive to dust, fingerprints and especially scratches. A scratched disc may not be able to be played back. Handle discs with care and store them in a safe place.

Proper Disc Storage

Place the disc in the center of the disc case and store the case and disc upright.	
Avoid storing discs in locations subject to direct sunlight, close to heating appliances or in locations of high humidity.	
Do not drop discs or subject them to strong vibrations or impacts.	
Avoid storing discs in locations where there are large amounts of dust or moisture.	

Handling Precautions

- If the surface is soiled, wipe gently with a soft, damp (water only) cloth. When wiping discs, always move the cloth from the center hole toward the outer edge.



- Do not use record cleaning sprays, benzene, thinner, static electricity prevention liquids or any other solvent.
- Do not touch the surface.
- Do not stick paper or adhesive labels to the disc.
- If the playing surface of a disc is soiled or scratched, the Player may decide that the disc is incompatible and eject the disc tray, or it may fail to play the disc correctly. Wipe any dirt off the playing surface with a soft cloth.

Cleaning the Pick Up Lens

- Never use commercially available cleaning discs. The use of these discs can damage the lens.
- Request the nearest service center approved by Sharp to clean the lens.

Warnings about dew formation

- Condensation may form on pick up lens or disc in the following conditions:
 - Immediately after a heater has been turned on.
 - In a steamy or very humid room.
 - When the Player is suddenly moved from a cold environment to a warm one.

When condensation forms:

It becomes difficult for the Player to read the signals on the disc and prevents the Player from operating properly.



To remove condensation:

Take out the disc and leave the Player with the power off until the condensation disappears. Using the Player when there is condensation may cause malfunction.

Copyright

- Audio-visual material may consist of copyrighted works which must not be recorded without the authority of the owner of the copyright. Refer to relevant laws in your country.
- This product incorporates copyright protection technology that is protected by U.S. patents and other intellectual property rights. Use of this copyright protection technology must be authorized by Macrovision, and is intended for home and other limited viewing uses only unless otherwise authorized by Macrovision. Reverse engineering or disassembly is prohibited.

U.S. Patent Nos. 4,631,603 and 4,907,093

- Manufactured under license from Dolby Laboratories. "Dolby" and the double-D symbol are trademarks of Dolby Laboratories.
- "DTS" and "DTS Digital Out" are trademarks of DTS, Inc.
-  is a trademark.
-  is a trademark of DVD Format/Logo Licensing Corporation.
- HDMI, the HDMI logo and High-Definition Multimedia Interface are trademarks or registered trademarks of HDMI Licensing LLC.
- Java and all Java-based trademarks and logos are trademarks or registered trademarks of Sun Microsystems, Inc. in the United States and/or other countries.

Getting Started

Step 1: Unpacking

Make sure the following accessories are provided with the product.

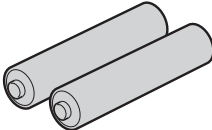
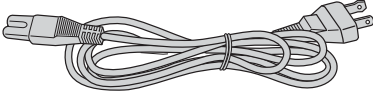
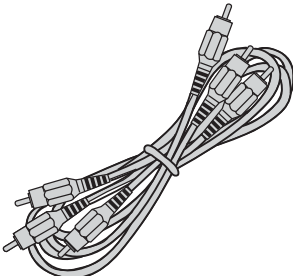
Remote control unit	“AAA” size battery (×2)	AC cord
		
	<p data-bbox="762 869 858 898">AV cable</p> 	

Step 2: Selecting equipment to connect

Connection varies with the equipment used. Refer to Connection (Pages 14-19).
Turn off the devices before connecting.

Step 3: Playing back discs

Play back a Blu-ray disc after connecting the Player to your favorite equipment.
Refer to Disc Playback. (Pages 20-32)

Step 4: Adjust settings

Adjust settings to enjoy various features and other functions for playing discs.
Refer to Settings (Pages 33-46).

Major Components

Main Unit (Front)

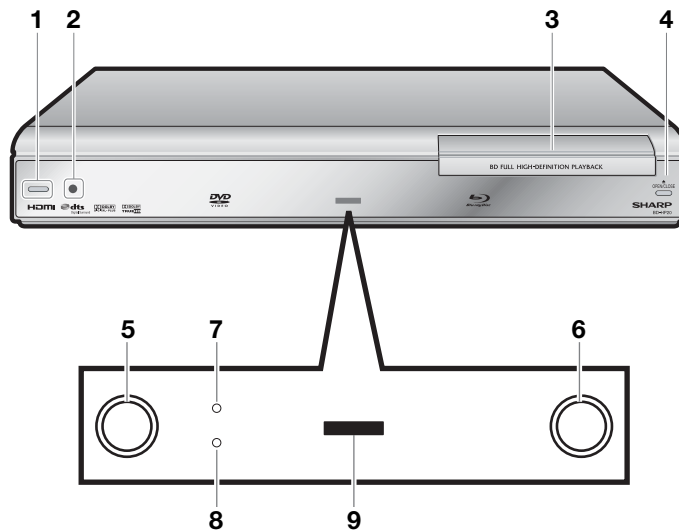

- 1 POWER (p. 22)
- 2 Remote control sensor (p. 20)
- 3 Disc tray (p. 24)
- 4 OPEN/CLOSE (p. 24)
- 5 DVD/CD mode indicator (p. 22)
- 6 BD mode indicator (p. 22)
- 7 ON indicator (p. 22)
- 8 STANDBY indicator (p. 22)
- 9 Front panel display (p. 22)

Main Unit (Rear)

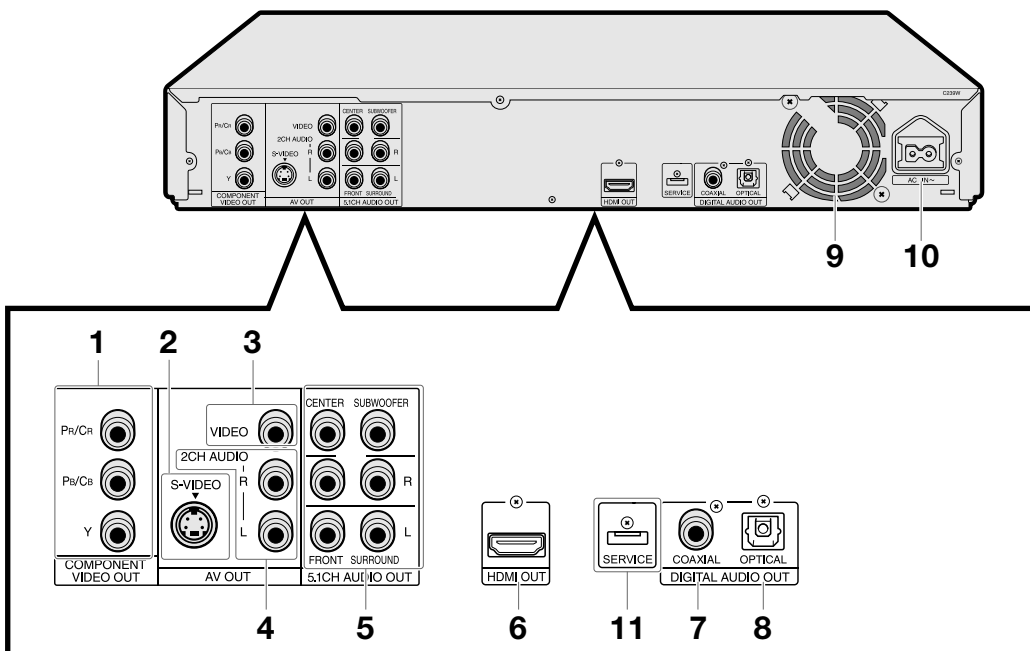

- 1 COMPONENT VIDEO OUT jacks (p. 15)
- 2 S-VIDEO output jack (p. 16)
- 3 VIDEO output jack (p. 16)
- 4 2CH AUDIO output jacks (p. 19)
- 5 5.1CH AUDIO OUT jacks (p. 17)
- 6 HDMI OUT terminal (p. 14)
- 7 DIGITAL AUDIO OUT COAXIAL jack (p. 18)
- 8 DIGITAL AUDIO OUT OPTICAL terminal (p. 18)
- 9 Cooling fan
The cooling fan operates while the power to the Player is on.
- 10 AC IN terminal (p. 20)
- 11 SERVICE terminal for software (p. 45)

Remote Control Unit

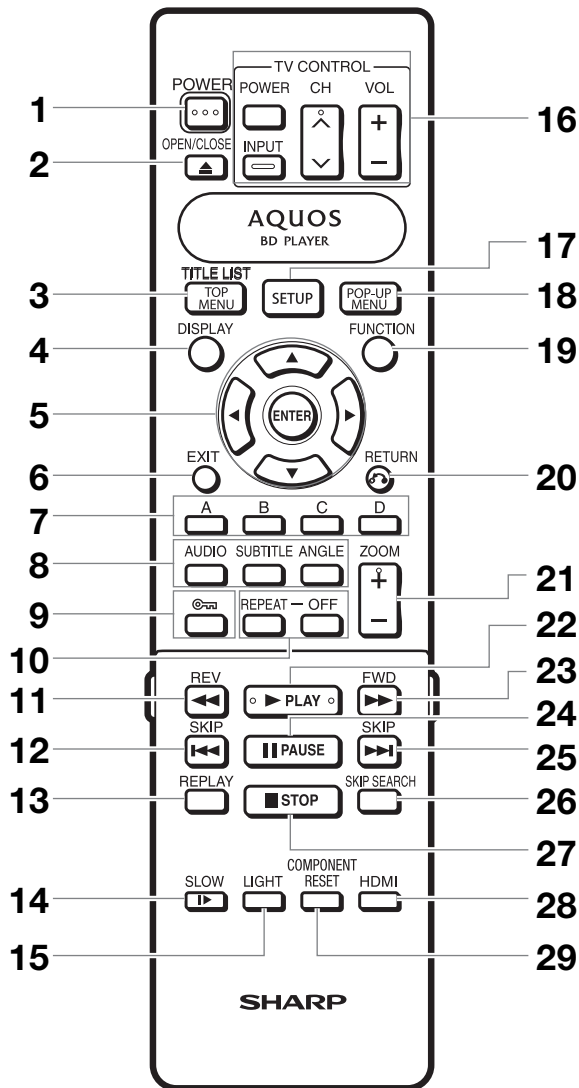

Buttons under the cover

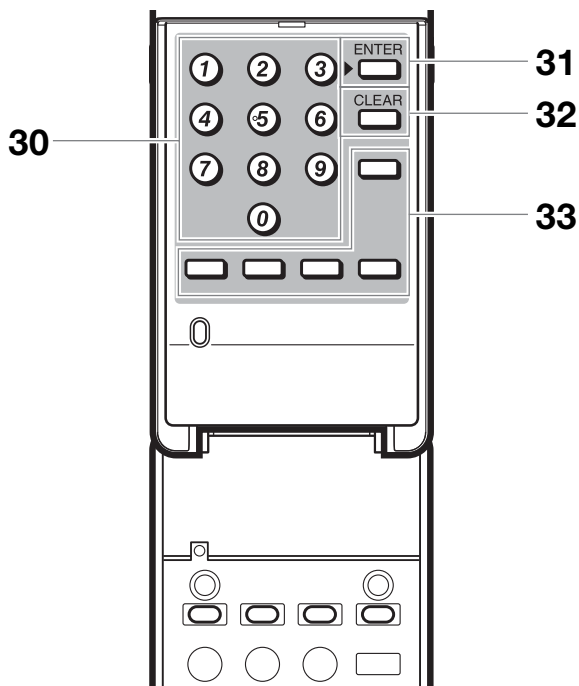

- 1 POWER (p. 22)
- 2 ▲ OPEN/CLOSE (p. 24)
- 3 TOP MENU, TITLE LIST (pp. 25, 26)
- 4 DISPLAY (p. 21)
- 5 Cursor buttons (▲/▼/◀/▶), ENTER (pp. 22, 36)
- 6 EXIT (pp. 22, 36)
- 7 A (Red), B (Green), C (Blue), D (Yellow) (p. 27)
- 8 AUDIO (p. 29), SUBTITLE (p. 29), ANGLE (p. 30)
- 9 🔒 (Lock) (See below.)
- 10 REPEAT (pp. 28, 29), OFF (for REPEAT) (pp. 28, 29)
- 11 ◀◀ REV (p. 28)
- 12 ◀◀◀ SKIP (p. 26)
- 13 REPLAY (p. 28)
- 14 ▶ SLOW (p. 28)
- 15 LIGHT (p. 23)
- 16 TV CONTROL buttons (p. 21)
- 17 SETUP (pp. 22, 36)
- 18 POP-UP MENU (p. 25)
- 19 FUNCTION (p. 31)
- 20 ↻ RETURN (p. 28)
- 21 ZOOM +/- (p. 28)
- 22 ▶ PLAY (p. 24)
- 23 ▶▶ FWD (p. 28)
- 24 || PAUSE (p. 28)
- 25 ▶▶▶ SKIP (p. 26)
- 26 SKIP SEARCH (p. 28)
- 27 ■ STOP (p. 24)
- 28 HDMI (p. 14)
- 29 COMPONENT RESET (p. 33)
- 30 Number buttons (p. 32)
- 31 ENTER (p. 32)
This button is the same operation as 5 ENTER.
- 32 CLEAR (p. 32)
To clear the input number
- 33 Non-functional buttons
These buttons on the remote control are non-functional. They have no operation at all.

Keylock function

You can set the keylock to prevent accidental operations. This function allows TVs compatible with AQUOS LINK to also perform a Key Lock on the player. Press and hold 🔒 (Lock) for more than 5 seconds.

- Each time you perform this operation, the function is activated or deactivated.
- If you try to operate the Player while the keylock function is set, "Hold" blinks on the front display panel to indicate that the keylock function is set.

Hold

NOTE

- This remote control unit is equipped with two **ENTER** buttons (5 and 31 listed above). The **ENTER** button under the cover is useful when using with the **Number** buttons.

Introduction to Connections

This Player is equipped with the terminals/jacks listed below. Find the corresponding terminal/jack on your video equipment. Using the supplied cable or commercially available cables, connect the video first. Then connect the audio.

Video terminals/jacks on this Player

	Higher Quality	① HDMI OUT terminal		▶	Page 14
		② COMPONENT VIDEO OUT jacks		▶	Page 15
		③ S-VIDEO output jack		▶	Page 16
	Standard Quality	④ VIDEO output jack		▶	Page 16

Audio terminals/jacks on this Player

Digital audio connection

	Higher Quality	① HDMI OUT terminal		▶	Page 14
	Standard Quality	② DIGITAL AUDIO OUT terminal or jack		▶	Page 18

Analogue audio connection

	Higher Quality	① 5.1CH AUDIO OUT jacks		▶	Page 17
	Standard Quality	② 2CH AUDIO output jacks		▶	Page 19

Video Connections

Connecting to the HDMI Terminal

You will enjoy high quality digital picture and sound through the HDMI terminal. When you use AQUOS LINK, make sure to use a certified HDMI cable.

STEPS

- 1: Be sure to turn off this Player and the equipment before making any connections.
- 2: Firmly connect an HDMI cable (commercially available) to the HDMI terminals (① and ②).

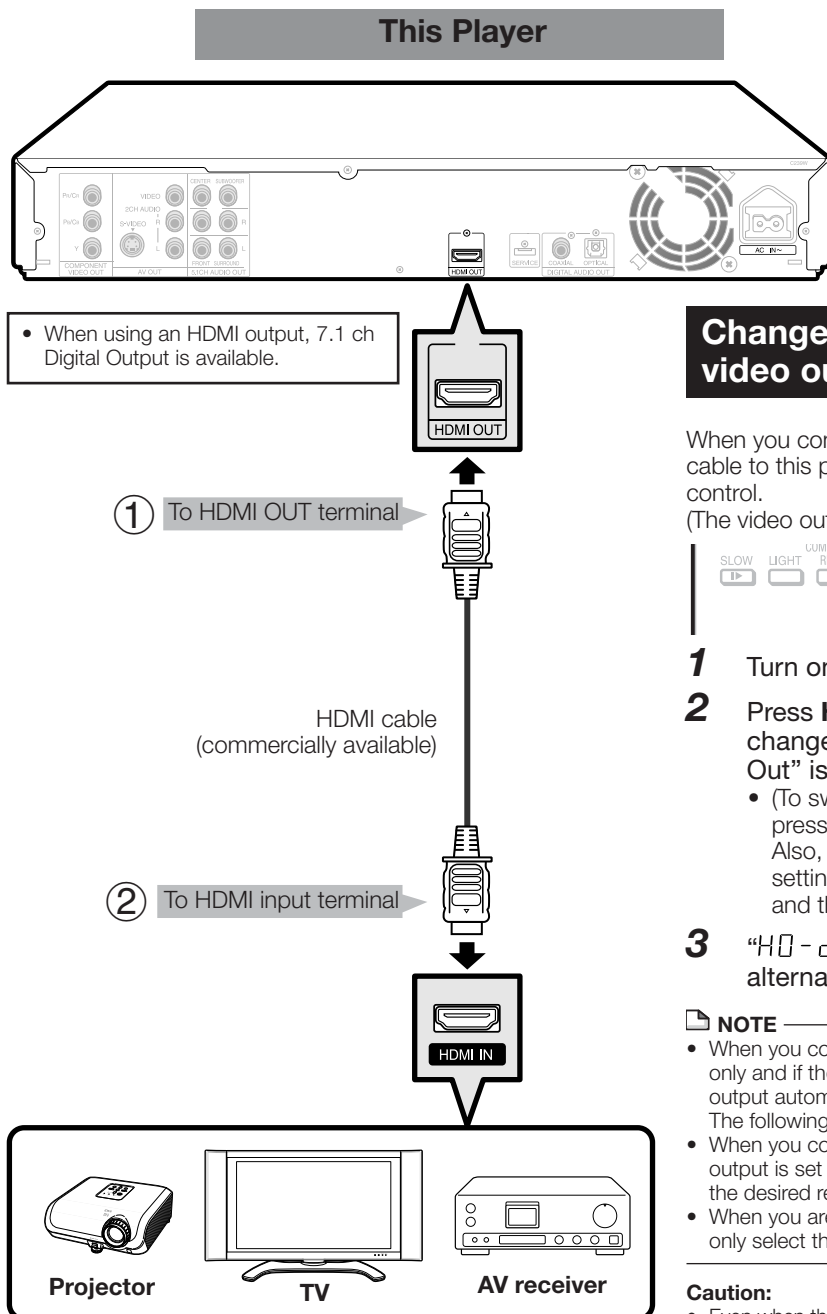

Caution:

- HDMI output and Component Video output can not be used at the same time.

Change the video output to HDMI video out

When you connect both an HDMI cable and a component cable to this player, switch to the output terminals by remote control. (The video output is not output both terminals.)



- 1 Turn on the power.
- 2 Press **HDMI** button for 5 seconds, and the change of “Component Video Out” and “HDMI Out” is possible.
 - (To switch outputs, it is necessary to keep the button pressed for several seconds.)
 - Also, when the HDMI button is pressed, the current setting conditions will display while flashing (blinking), and then the selected output lamp displays.
- 3 “**HD-out**” or “**CP-out**” is displayed alternately on the front panel display.

NOTE

- When you connect this player to a SHARP TV with an HDMI cable only and if the TV is on, the video output is changed to HDMI output automatically. The following setting is unnecessary.
- When you connect to the TV with an HDMI cable only, HDMI video output is set to AUTO. If you don't get the normal image, select the desired resolution.
- When you are setting HDMI video output besides AUTO, you can only select the resolution that corresponds to the connected TV.

Caution:

- Even when there is no cable connected to the Component video out, switching the output to CP-out (Component video out) is still possible. When CP-out is selected, there will be no signal from the HDMI video out.

Equipment with an HDMI terminal

After connecting

- Load a disc and start playback. (Pages 24-27)
- If desired, connect audio equipment. (Pages 17-19)
- Refer to AQUOS LINK function. (See page 23 and 40)

Video Connections

Connecting to the Component Jacks

You will enjoy accurate color reproduction and high quality images through the component jacks.

STEPS

- 1: Be sure to turn off this Player and the equipment before making any connections.
- 2: Firmly connect a component video cable (commercially available) to the component jacks (① and ②).

Caution:

- HDMI output and Component Video output can not be used at the same time.

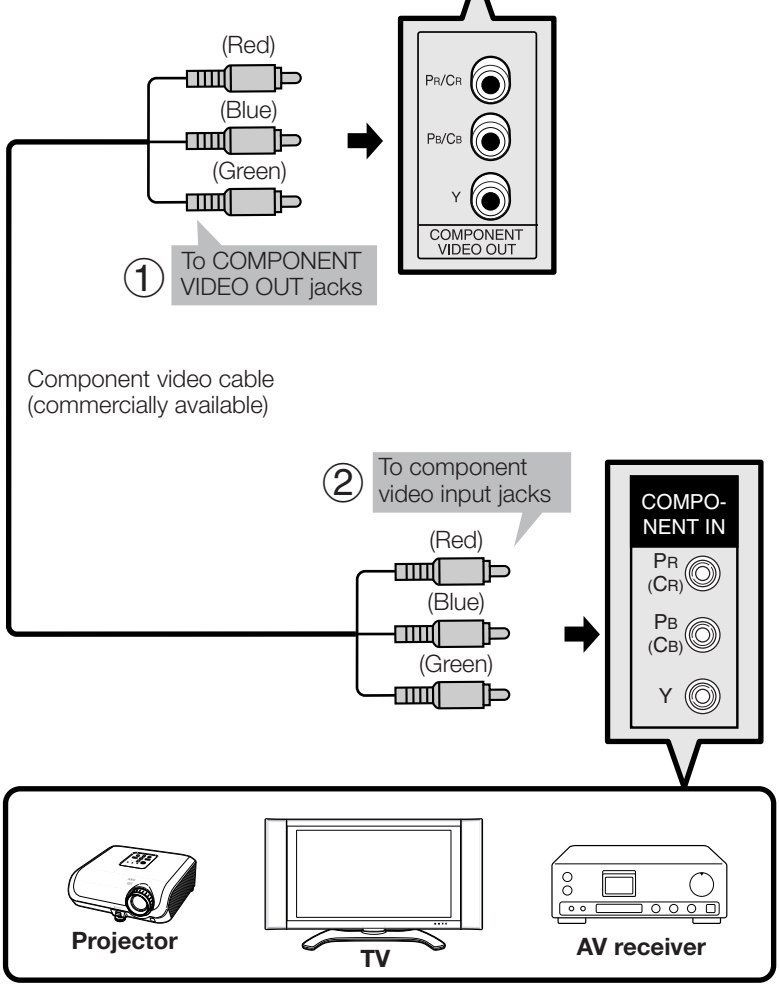
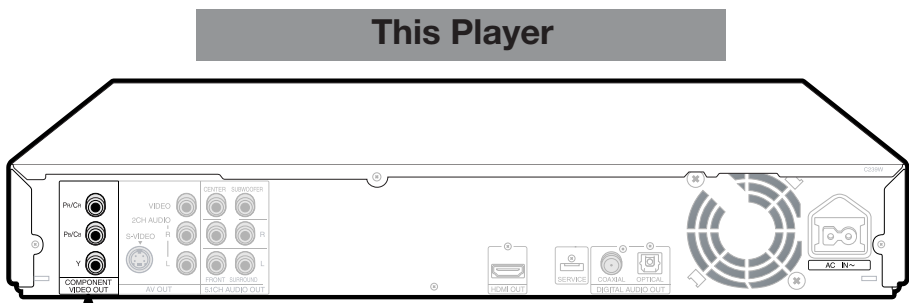

Video equipment with component jacks

Caution:

- Press **HDMI** button for 5 seconds, and the change of “Component Video Out” and “HDMI Out” is possible.
- Even when there is no cable connected to the HDMI video out, switching the output to HO-out (HDMI video out) is still possible. When HO-out is selected, there will be no signal from the Component video out.

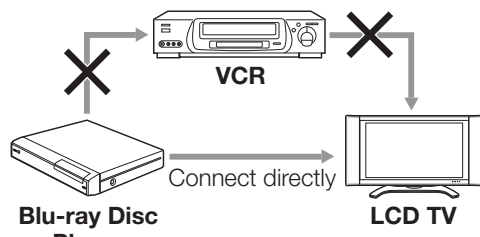

NOTE

- Connect the Blu-ray disc player to LCD TV directly. If you playback the image via VCR, the image may deteriorate due to the copy guard function.
- When you record the program where copyright is protected, the copy guard function is activated automatically; the program can not be recorded correctly. Also, the playback image via VCR may deteriorate due to this function. However, this is not a malfunction. When you watch the program where copyright is protected, we recommend that the Blu-ray disc player be connected to LCD TV directly.

After connecting

- Connect audio equipment or the audio terminals of the TV. (Pages 17-19)

Connecting to the S-video or Video Jack

You will enjoy the images through the S-video or video jack.

STEPS

1: Be sure to turn off this Player and the equipment before making any connections.
 2: Firmly connect an S-video cable (commercially available) or AV cable (supplied) to the S-video or video jacks (1 and 2, or 3 and 4).

This Player

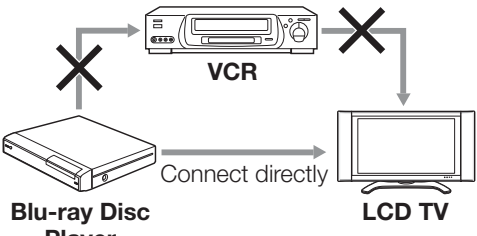
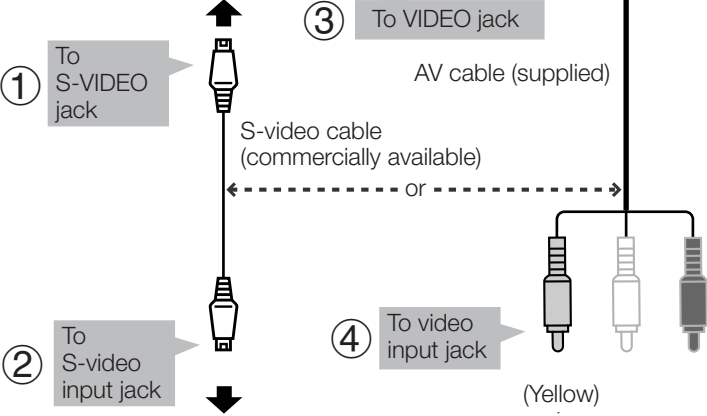
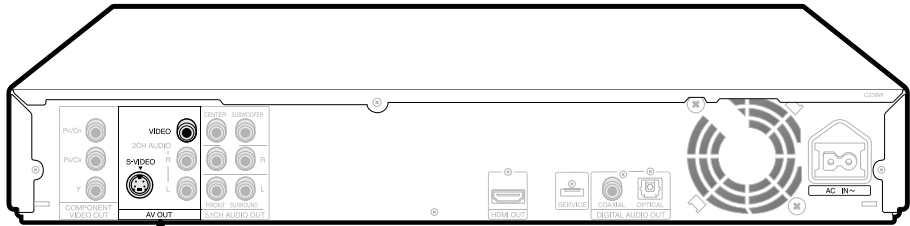

NOTE

- Connect the Blu-ray disc player to LCD TV directly. If you playback the image via VCR, the image may deteriorate due to the copy guard function.
- When you record the program where copyright is protected, the copy guard function is activated automatically; the program can not be recorded correctly. Also, the playback image via VCR may deteriorate due to this function. However, this is not a malfunction. When you watch the program where copyright is protected, we recommend that the Blu-ray disc player be connected to LCD TV directly.

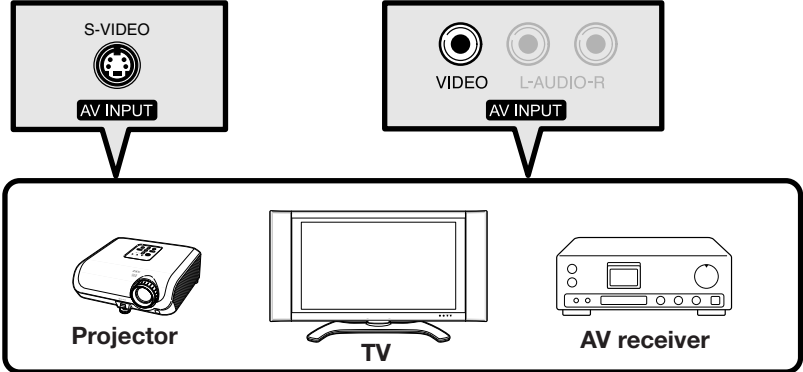

Video equipment with an S-video or video jack

After connecting

- Connect audio equipment or the audio terminals of the TV. (Pages 17-19)

Audio Connections

Connecting 5.1 ch Speakers through an Amplifier

You can connect up to 5 speakers and a subwoofer to the 5.1CH AUDIO OUT jacks using an amplifier.

STEPS

- 1: Be sure to turn off this Player and the equipment before making any connections.
- 2: Firmly connect the audio cables to the 5.1CH AUDIO OUT jacks.

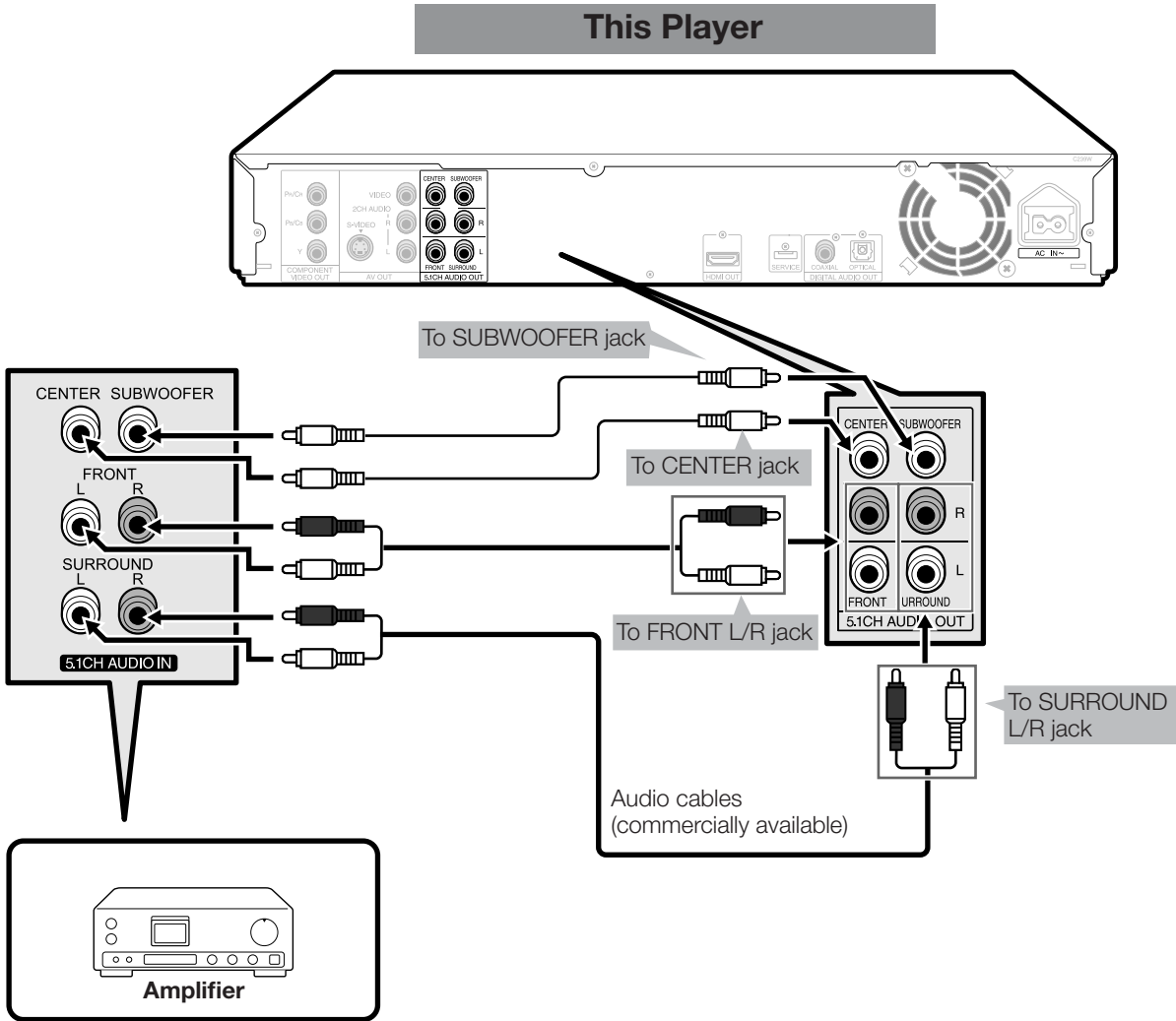

2 Connection

NOTE

- You can also connect 2 ch stereo speakers through an amplifier. In this case, set the jacks without any speakers connected to "NONE". (Pages 37-39)

After connecting

- Set the size, distance and level of each speaker. (Pages 37-39)
- Load a disc and start playback. (Pages 24-27)

Connecting to the Digital Audio Terminal or Jack

You can connect audio equipment to the DIGITAL AUDIO OUT terminal or jack.

STEPS

- 1: Be sure to turn off this Player and the equipment before making any connections.
- 2: Firmly connect an optical digital cable (commercially available) to the optical digital audio terminals or a coaxial digital cable (commercially available) to the coaxial digital audio jacks (① and ②, or ③ and ④).

This Player

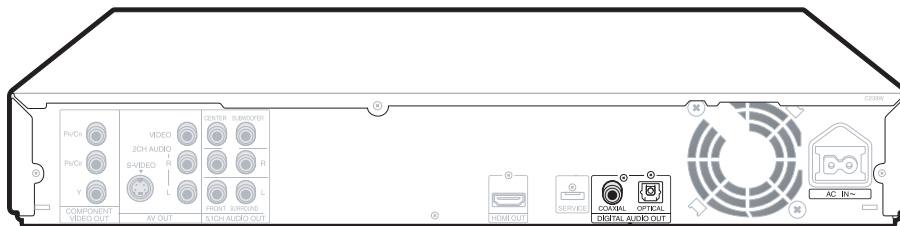

- When using COAXIAL/OPTICAL output, 5.1 ch Digital Output is available. 7.1 ch Digital Output is not available.

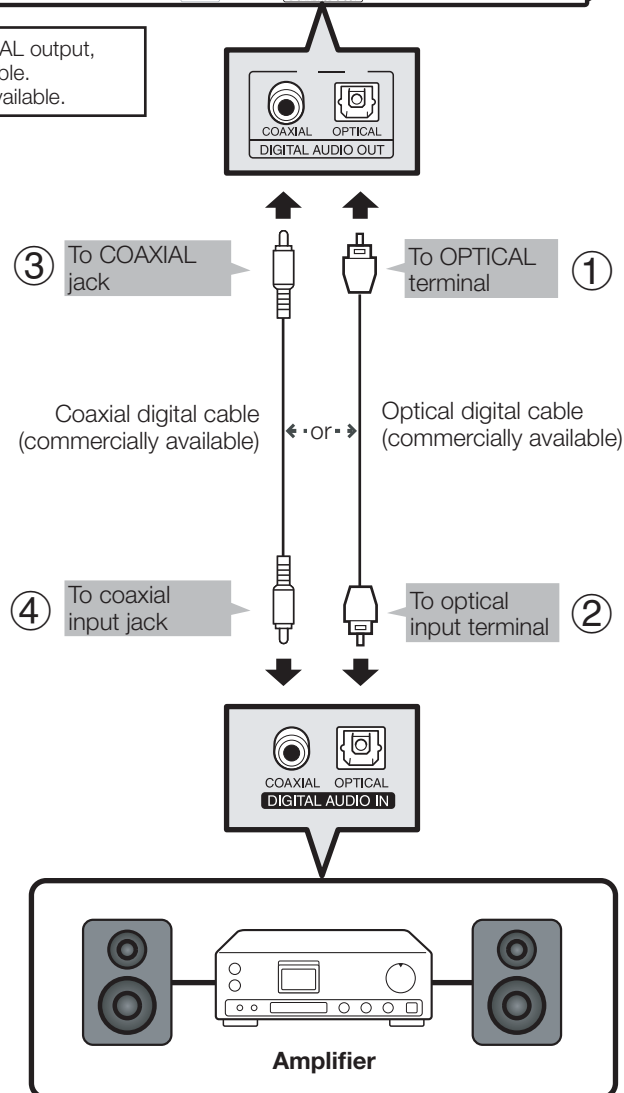

Audio equipment with a digital audio input terminal or jack

After connecting

- Load a disc and start playback. (Pages 24-27)

Audio Connections

Connecting the Audio Jacks

You can connect audio equipment or the TV to the 2CH AUDIO output jacks.

STEPS

- 1: Be sure to turn off this Player and the equipment before making any connections.
- 2: Firmly connect the AV cable (supplied) to the audio jacks (1 and 2).

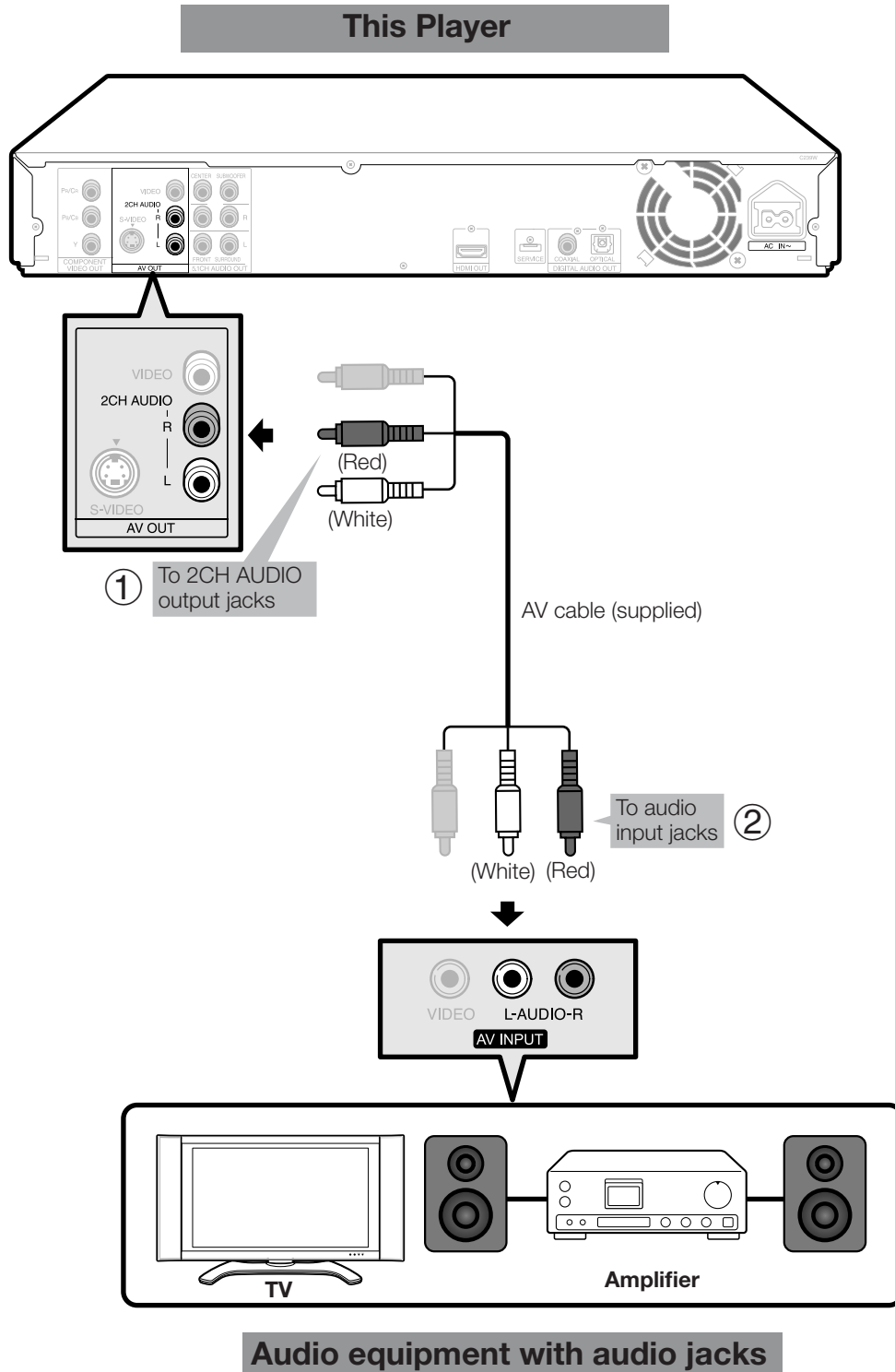

After connecting

- Load a disc and start playback. (Pages 24-27)

Before Starting Playback

Loading the Batteries in the Remote Control

- 1 Press down on the tab in the direction of the arrow to remove the battery cover.

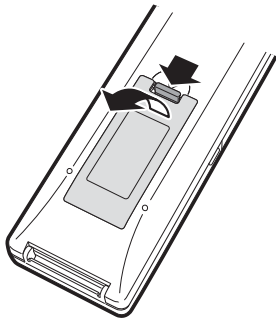

- 2 Load the two R-03 size batteries ("AAA" size, UM/SUM-4) supplied with the remote control unit. Make sure that the battery poles \oplus and \ominus are positioned as indicated.

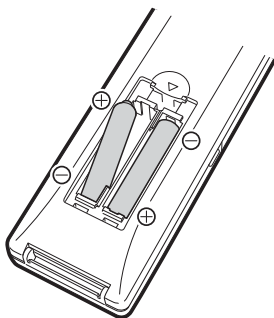

- 3 Slide the battery cover in the direction of the arrow until it clicks.

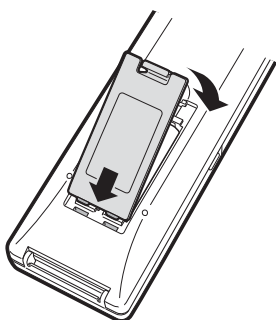

NOTE

- Do not subject the remote control unit to shock, water or excessive humidity.
- The remote control unit may not function if the Player's remote sensor is in direct sunlight or any other strong light.
- Incorrect use of batteries may cause them to leak or burst. Read the battery warnings and use the batteries properly.
- Do not mix old and new batteries, or mix different brands.
- Remove the batteries if you will not use the remote control unit for an extended period of time.

Approximate operating range of remote control

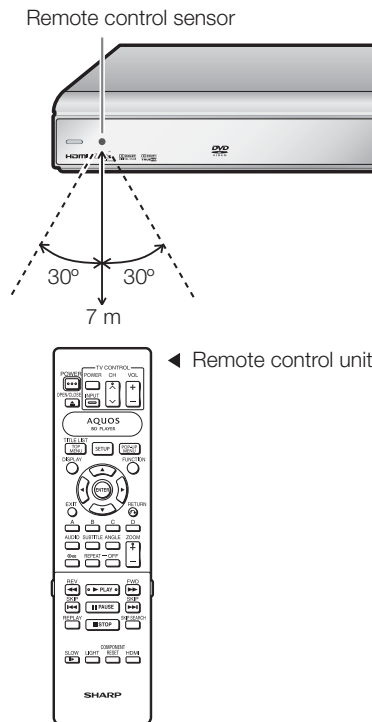

Connecting the Power Cord

Plug the supplied AC cord into the AC IN terminal on the rear of the Player. Then plug into AC outlet.

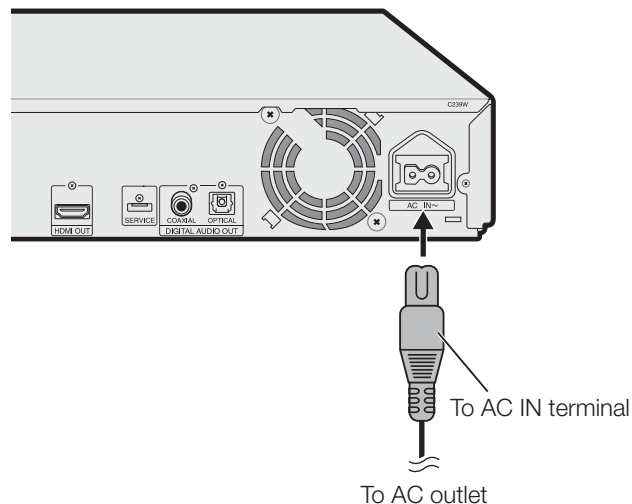

NOTE

- Place the Player close to the AC outlet, and keep the power plug within reach.
- TO PREVENT RISK OF ELECTRIC SHOCK, DO NOT TOUCH THE UN-INSULATED PARTS OF ANY CABLES WHILE THE AC CORD IS CONNECTED.
- The STANDBY indicator blinks while the Player is preparing for starting up. You cannot turn the Player on until the STANDBY indicator stops blinking.

Before Starting Playback



Setting the Remote Control Code

- 3 types of remote control codes operate this Player: RC-1, RC-2 and RC-3. If you operate this Player by remote control along with another SHARP Blu-ray Disc Player or DVD Player placed next to it simultaneously, switching the remote control code (both the Player and remote control) to one of the signals (RC-1, RC-2 or RC-3) will let you operate only with this Player.
- Make sure to set the Player and remote control to the same remote code. You can not operate the Player if they are not set to the same code.

Setting the Remote Control Code of the Remote

Example: Setting the code to "RC-3".

- 1** Press and hold **3** first and then **POWER** on the remote control together for more than 5 seconds.
- 2** Press **POWER** to turn off the player.

POWER

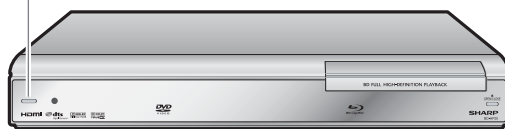

Setting the Remote Control Code of the Player

- 3** Point the remote control at the player, then press and hold the **DISPLAY** button.

Remote control sensor



The display on the player changes as shown below, and the player will be set to the same number as the remote control.

Example: Change "RC-1" to "RC-3".

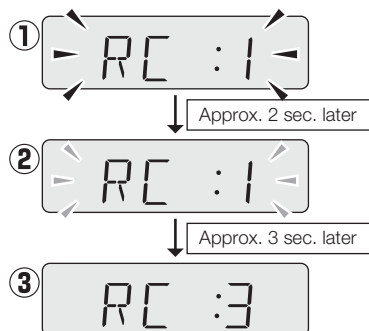

If remote control does not work

First, press **Power** to turn on the player. Press **POWER** on the remote control and check the front panel display (RC-1, RC-2 or RC-3). Set the remote control code according to the display and press **POWER** to see if you can turn on/off the Player.

Operating a SHARP TV Using the Remote Control

The Universal Remote Control may operate the basic functions of the SHARP TV.

TV function control

- TV Power: POWER
- TV Channel up/down: CH \wedge / \vee
- TV Volume up/down: VOL + / -
- TV-AV Selector: INPUT

Before Starting Playback

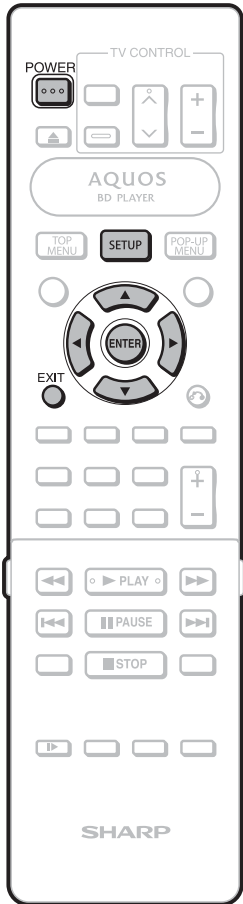

Turning the Power On

Turning the power on

Press **POWER** on the remote control or on the Player to turn on the power of the Player.



Entering standby

Press **POWER** on the remote control or on the Player to enter standby.

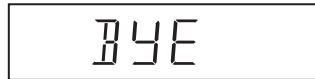

- If you press **POWER** again immediately after entering standby, the Player may not turn on. If this happens, wait for 10 seconds or more and then turn on the power again.

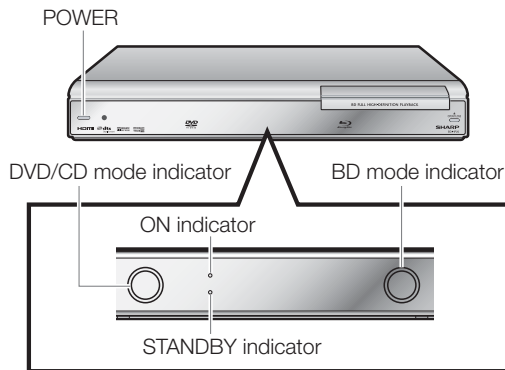

Indicators on the Player

ON indicator

Green on	Power on
----------	----------

STANDBY indicator

Red blinks	Preparing for standby
Red on	Standby

BD and DVD/CD mode indicators

Off	No disc
Blue on	Playing back
White on	Disc stopped
White blinks	Loading a disc

- When you turn on the **POWER**, the **MENU** screen automatically displays for a while. Press **EXIT** to erase the display.

Language Setting

Changing the on-screen display language

- 1 Press **SETUP** to display the **SETUP MENU** screen.



- 2 Press **▲/▼/◀/▶** to select "ON SCREEN LANGUAGE", then press **ENTER**.

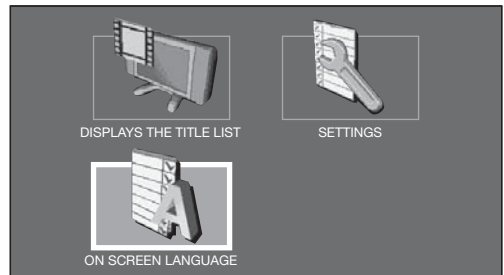

- 3 Press **▲/▼/◀/▶** to select the language you want to display on the screen, then press **ENTER**.

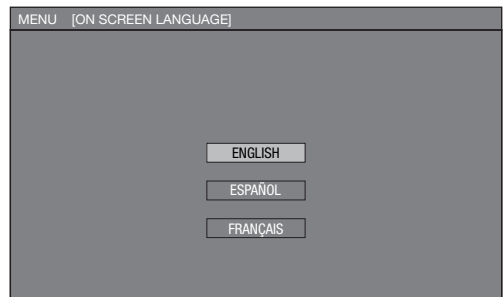

- 4 Press **SETUP** or **EXIT** to exit.

NOTE

- To select the DVD disc language, such as subtitle language, etc., (See page 25)

Before Starting Playback

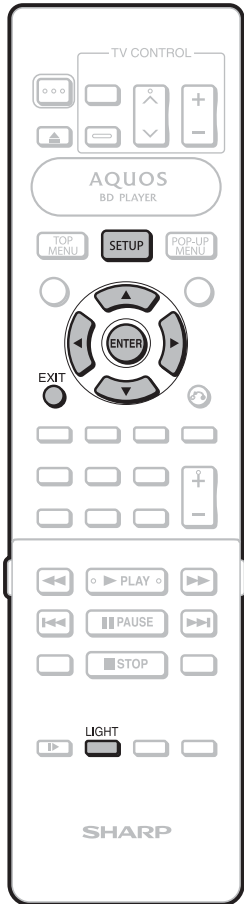

Turning Off the LCD Backlight and Indications

If you feel that the indicators on the Player are too bright when watching movies, you can turn them off except for the ON indicator.

Quick operation

Press **LIGHT** to turn the LCD backlight on or off.

SETUP MENU operation

- 1 Press **SETUP** to display the SETUP MENU screen.
- 2 Press **▲/▼/◀/▶** to select “SETTINGS”, then press **ENTER**.
- 3 Press **▲/▼** to select “FRONT DISPLAY/LED”, then press **ENTER**.

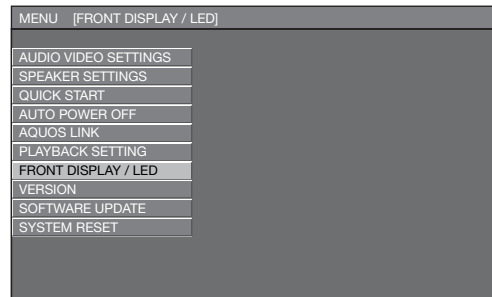

- 4 Press **◀/▶** to select “ON” or “OFF”, then press **ENTER**.
- 5 Press **SETUP** or **EXIT** to exit.

Using AQUOS LINK

Controlling the Blu-ray disc player using AQUOS LINK

What is AQUOS LINK?

Using the HDMI CEC(Consumer Electronics Control), with AQUOS LINK you can interactively operate this player with your SHARP AQUOS TV.

What you can do with AQUOS LINK

When you connect this player to the LCD TV compatible with AQUOS LINK using an HDMI cable, you can perform the function listed below. (See page 14 for connecting to the HDMI terminal)

Playback function turns on the LCD TV immediately.

When you start to playback of this player, Power of LCD TV will be turned on and the playback image will appear on the screen.

Automatic input select function

When you start playback of this player, the input selector of the LCD TV will automatically switch to the LCD TV input terminal connected to the player and the playback image will appear on the screen, even if you are watching a TV program.

Automatic power off function

If you turn off the LCD TV when this player is in stop mode, the power of this player will be turned off automatically. (In the case, while playing back a disc, the power does not turn off.)

Automatic power on function

When you switch to the LCD TV input terminal connected to this player, the power of this player will be turned on automatically.

NOTE

- In order to make AQUOS LINK available, set up AQUOS LINK on the LCD TV that is connected to this player. See page 40 regarding the setup of this player. Refer to the Operation Manual of the TV for details regarding setup.

BD/DVD/CD Playback



This section explains playback of commercially available BD Video and DVD Video discs (like movies), CDs, and recorded DVD-RW/R discs.

Loading a Disc

- 1 Press **POWER** to turn on the power.
- 2 Press **OPEN/CLOSE** to open the disc tray.

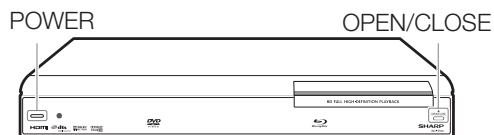

- 3 Load a disc on the disc tray.

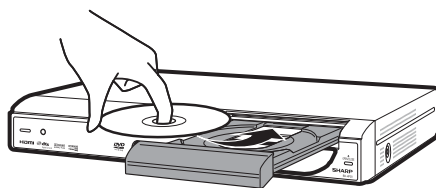

- Insert the disc with the label face up.
- In case of disc recorded on both sides, face down the side to play back.

- 4 Press **OPEN/CLOSE** to close the disc tray.

BD/DVD Video Playback

BD VIDEO **DVD VIDEO**

- 1 Load a disc.
 - Playback may begin automatically, depending on the disc.
- 2 Press **▶ PLAY**.
 - Playback begins from the first title.
 - The menu may be displayed first, depending on the disc. Perform playback operation by following the directions on the screen.

To stop playback

Press **■ STOP**.

Resume playback function

- If you press **▶ PLAY** next, playback will resume from the point where the Player was previously stopped. To playback from the beginning, cancel resume mode by pressing **■ STOP**, then press **▶ PLAY**. (This may not work depending on the type of disc. In this case, open the disc tray or enter standby.)

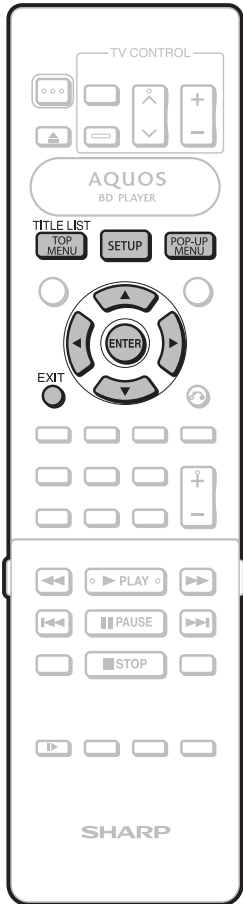

BD/DVD Menus

BD VIDEO **DVD VIDEO**

- This section explains how to play back a BD/DVD video disc with a top menu or disc menu.
- The titles listed in the top menu and a disc guide (for options like subtitles and audio languages) are given in the disc menu.

Start playback by selecting a title from the top menu

- 1 Press **TOP MENU**.
 - The top menu screen is displayed.



- 2 Press **▲/▼/◀/▶** to select the title, then press **ENTER**.
 - The selected title is played back.

NOTE

- The procedure explained on this page is the basic operation procedure. Procedures vary depending on the BD/DVD video disc, so you may need to follow the instructions in the BD/DVD video disc manual or the instructions displayed on the screen.
- A top menu is not displayed for a DVD-RW/R (Video mode) if it has not been finalized.

Top menu

- With some BD/DVD discs, the top menu may be referred to as the "Title Menu". Use **TOP MENU** on the remote control when the instructions refer to "Title Menu".
- If no top menu is available, the **TOP MENU** button will have no effect.

Using the disc menu

Example: Select "SUBTITLE LANGUAGE".

- 1 Press **POP-UP MENU**.
 - The disc menu screen is displayed.
- 2 Press **▲/▼** to select "SUBTITLE LANGUAGE", then press **ENTER**.
 - The screen for selecting the subtitle language is displayed.

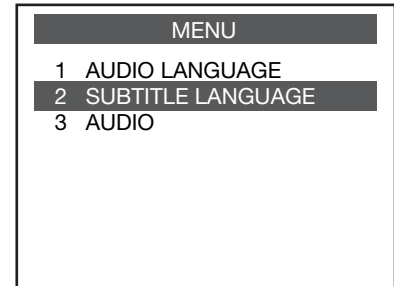

- 3 Press **▲/▼** to select the subtitle language, then press **ENTER**.

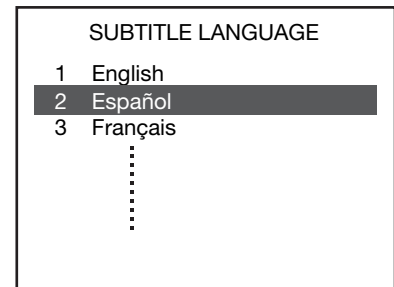

- 4 Press **SETUP** or **EXIT** to exit.

BD/DVD/CD Playback

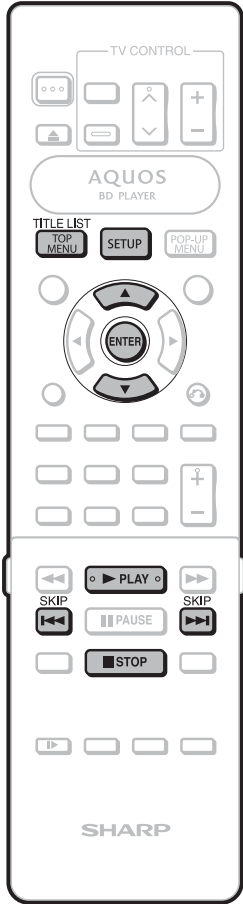

BD-R/-RE/DVD-R/-RW Playback

BD-R **BD-RE** **DVD-R** **DVD-RW**

You can play back a disc recorded. (finalized disc only)

Playback from the beginning

- 1 Load a disc recorded in Video mode.
- 2 Press **▶ PLAY**.
 - Playback begins from title 1.

Playback by selecting a title

- 1 Load a disc recorded in Video mode.
- 2 Press **TOP MENU**.
 - The TITLE LIST screen is displayed.
 - The TITLE LIST screen also can be displayed by pressing **ENTER** after choosing **"DISPLAYS THE TITLE LIST"** in **SETUP MENU**

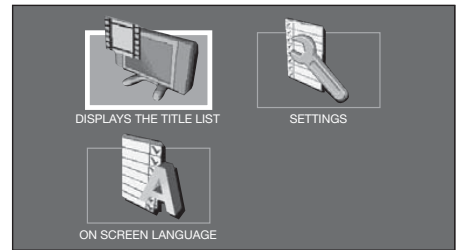

- When more than seven titles are displayed, switch pages by pressing **◀◀ SKIP** or **▶▶ SKIP**.

MENU [TITLE LIST (DVD: ORIGINAL)]				
PROGRAM 1				
5/21	FRI	9:30 AM	110 MIN.	
[FROM OLD]				
1	PROGRAM 1	5/21	FRI	110 MIN.
2	PROGRAM 2	8/15	FRI	110 MIN.
3	PROGRAM 3	7/3	MON	56 MIN.
4	PROGRAM 4	9/18	THU	40 MIN.
<input type="radio"/> B SORTING <input type="radio"/> C PLAYLIST <input type="radio"/> D FUNCTIONS				

Information of selected title

Title Name
Recording Date
Recording Duration

Caption for Color Button

- 3 Press **▲/▼** to select the title, then press **ENTER**.
 - Playback of the selected title will begin.
 - You can playback by pressing **▶ PLAY** instead of pressing **ENTER**.
- 4 Press **■ STOP** to stop playback.

NOTE

- "Finalize" in this manual refers to making sure to have a recording device process on the recorded disc so that it will play in other DVD players as well as this player. Only finalized discs will playback in this player.

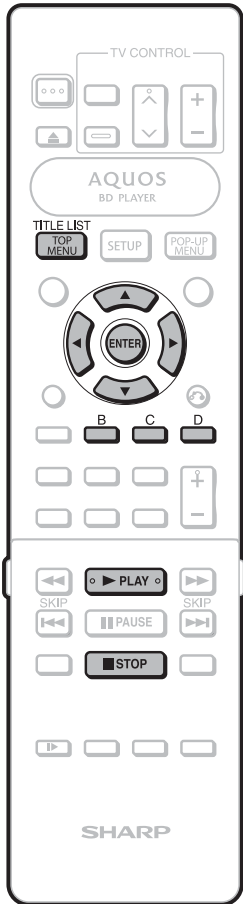

Playback by selecting a PLAY LIST

- 1 Load a disc recorded in Video mode.
- 2 Press **TOP MENU**.
 - The TITLE LIST screen is displayed.
- 3 Press **C (Blue)**, then press **ENTER**.
 - The PLAY LIST screen is displayed.

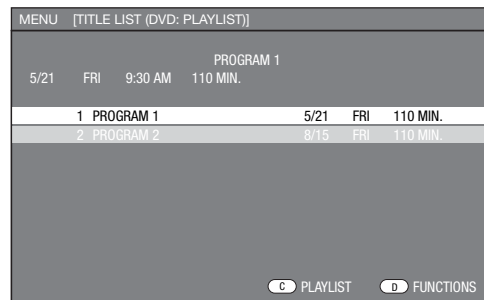

- 4 Press **▲/▼** to select the title, then press **ENTER**.
 - Playback of the selected title will begin.
- 5 Press **■ STOP** to stop playback.

Sorting the titles

- 1 Press **B (Green)**, then press **ENTER** while The TITLE LIST screen is displayed.
- 2 Select the type of sorting by pressing **▲/▼**, then press **ENTER**.

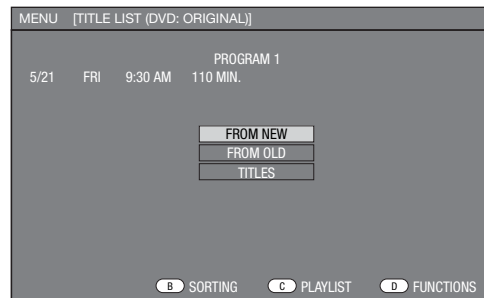

- The displayed titles are rearranged by selected sorting type.

Playing back the title you stopped while being played.

- 1 Press **D (Yellow)** while the TITLE LIST screen is displayed.

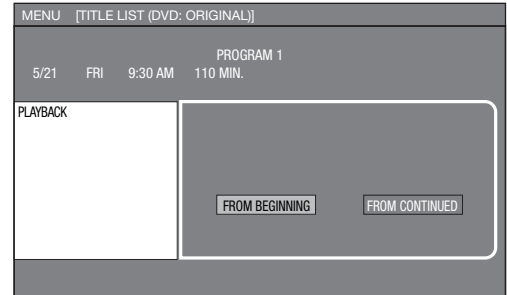

- 2 Press **◀/▶** to select the type of Playback, then press **ENTER**.
 - Playback of the title will begin.

NOTE

- If a disc recorded in Video mode has been finalized, a menu screen will be created automatically to enable playback with other BD/DVD players. Because of this reason, the menu screen is different before and after finalization.
- "Finalize" in this manual refers to making sure to have a recording device process on the recorded disc so that it will play in other DVD players as well as this player. Only finalized discs will playback in this player.

Audio CD Playback

Playback from the beginning

- 1 Load an audio CD.
- 2 Press **▶ PLAY**.
 - Playback begins from the first track.
- 3 Press **■ STOP** to stop playback.

Playback Functions

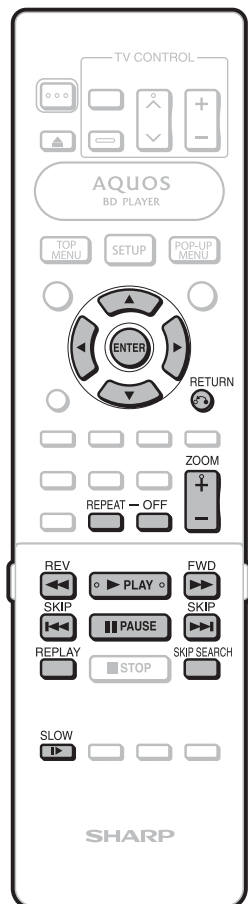

BD VIDEO | BD-R | BD-RE
 DVD VIDEO | DVD-R | DVD-RW
 AUDIO CD

Fast Forward/Reverse (Search)

Fast Forward/Reverse functions when ◀◀ **REV** or ▶▶ **FWD** is pressed during playback.

Example: When ▶▶ **FWD** is pressed

- The search speed will cycle as follows each time you press the button.

When playing back a DVD

- You cannot fast forward or fast reverse from one title and continue to another title (except when playing audio CDs).

Skipping to the Next or the Start of the Current Chapter (Track)

Skipping (to the beginning of a chapter or track) functions when ◀◀ **SKIP** or ▶▶ **SKIP** is pressed during playback.

Slow Playback

Slow Playback functions when ▶ **SLOW** is pressed during playback.

- This doesn't work for audio CDs.
- Press ▶ **PLAY** to return to normal playback.

Pause/Frame Advance Playback

- Pause functions when || **PAUSE** is pressed during playback. (If you are playing back an audio CD, the CD will also pause.)
- Frame Advance Playback functions when ▶▶ **SKIP** is pressed during Pause.
- Frame Advance Playback may not function properly with discs other than DVD-RW (VR mode).
- Some BD/DVD Video discs are not compatible with Pause/Frame Advance Playback.

Skip Search

Playback skips 30 seconds ahead when **SKIP SEARCH** is pressed during playback.

Replay

Playback jumps back 10 seconds when **REPLAY** is pressed during playback.

Repeat Playback of a Title or Chapter (Repeat Playback)

- Play back the title or chapter you want to repeat.
- Press **REPEAT**.
- Press ◀/▶ to select the type of Repeat Playback.

- PLAYING BACK TITLE:** Repeats the title currently being played back.
- PLAYING BACK CHAP:** Repeats the chapter currently being played back.
- SCENE SELECTION:** Repeats the specified scene of title or chapter.

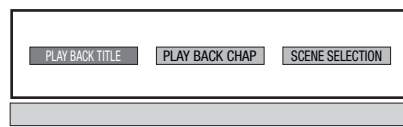

- Press ↶ **RETURN** to cancel without setting the type of Repeat Playback.
- For Audio CD, you can select "PLAYING DISC" "PLAYING TRACK" and "SPECIFY THE PART" as Repeat Playback options.

- Press **ENTER**.

Example: Repeat playback of a title (TITLE)

◀ TITLE REPEAT

- Press **REPEAT-OFF** to return to normal playback.

Enlarge the playback image (Zoom function)

- Press **ZOOM +** while playback.
 - Three steps can be operated.
 - Some discs will not be performed on this player.
- The area that you want to watch is moved using ▲/▼/◀/▶.
- If you want to return the image, press **ZOOM -**. Press **ZOOM -** several times until it will return.

NOTE

- This function is not available for AUDIO CD.
- Zoom function will not operate when subtitle is set to ON.
- Zoom function will be cancelled when ◀◀ **REV** or ▶▶ **FWD** is pressed.
- Zoom function will be cancelled when || **PAUSE** is pressed, depending on the disc.

Playback Functions

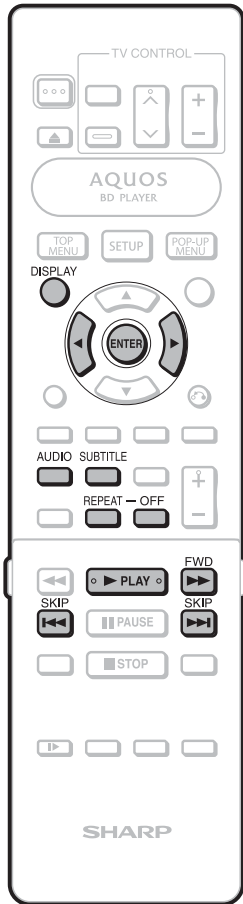

Partial Repeat Playback (Repeat Playback of a Specified Part)

- 1 Press **REPEAT** during playback.
- 2 Press **◀▶** to select "SCENE SELECTION", then press **ENTER**.

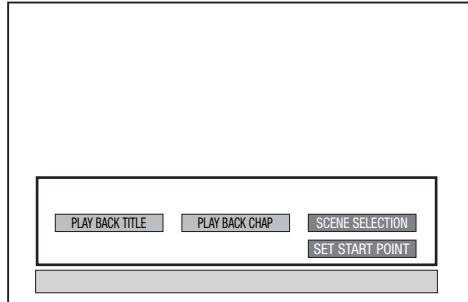

- 3 "SET START POINT" displays, press **ENTER** at the scene where you want.
 - "SET END POINT" displays.
- 4 Press **ENTER** at the scene where you want to set the end point.
 - You can press **▶▶ FWD** to fast forward to the scene where you want to set the end point. When you reach the desired scene, simply press **▶ PLAY** and then **ENTER** to set the end point. To cancel Repeat Playback, press **REPEAT-OFF**.

NOTE

- Press **▶▶ SKIP**, the Repeat Playback is cancelled and the next chapter being played back.
- Press **◀◀ SKIP** once, the Repeat Playback is cancelled and the player returns to the start of current chapter (track).
- If you press **◀◀ SKIP** again (within about 5 seconds) the player will skip to the beginning of the previous chapter (track).
- For Partial Repeat Playback, set the start and end points within the same title.
- Repeat Playback may be forbidden depending on the disc.
- Partial Repeat Playback may not work in multi-angle scenes.
- If you press **DISPLAY**, you can confirm the Repeat Playback status.

Switching Audio

You can change the audio output channel using **AUDIO**.

Each time **AUDIO** is pressed, the audio channels change as follows:

BD VIDEO | **DVD VIDEO**

The audio track currently being played back will be displayed.

BD-RE | **BD-R** | **DVD-RW** | **DVD-R**
VR MODE

When a recorded broadcast with a **Secondary Audio Program** is played back: Switches between "L", "R" and "L+R".

When a recorded broadcast with **stereo or monaural audio** is played back:

"Stereo" is displayed. (Audio cannot be switched.)

NOTE

- When you play a program recorded in stereo or monaural, and if you are listening to the BITSTREAM sound via the digital output jack, you cannot select the audio channel. Set "AUDIO OUT" to "PCM" (page 35), or if you want to change the audio channel, listen via the analog output jacks.

Switching Subtitles

If subtitles are provided in multiple languages, you can switch between them.

Press **SUBTITLE** during playback.

- The display indicates the subtitle number currently being played back, and the subtitles appear. Each time **SUBTITLE** is pressed, the subtitles change.
- "—" is displayed if a disc has no subtitles.
- You can also select "OFF".

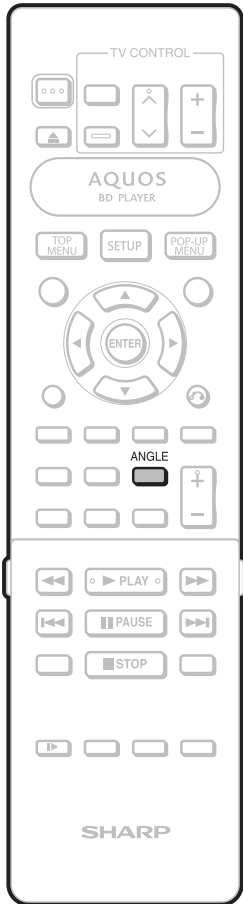

Switching the Angle

If multiple angles are recorded, you can switch between them.

- 1** Press **ANGLE** during playback.
 - The display indicates the angle number currently being played back. Each time you press **ANGLE**, the angle switches.
 - “- -” is displayed if a disc is recorded with only one angle.

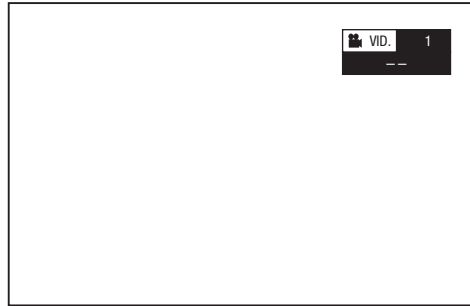

To return to the previous angle, press **ANGLE** to cycle through the angles until you return to the original angle.

Displaying the Angle Mark

You can change settings so that Angle Mark appears in the right bottom part of the screen when multiple angles are recorded. The settings can be changed in “SETTINGS” - “PLAYBACK SETTING” - “ANGLE MARK DISPLAY”. (Page 41)

NOTE

- Settings for audio, subtitles and angle can be changed also in Function Control Screen. (Page 31)
- The operations of subtitles, angle and audio differ according to each disc. You may need to refer to the operation manual of the disc.
- The following operations will not work when playing back an audio CD: Slow Playback, Frame Advance

Display of functions

- The display for subtitles, angle or audio automatically disappears after 5 seconds.

Switching between functions

- You can switch the subtitles, angle and audio at the Function Control screen. (Page 31)
- The operation for each function varies depending on the disc. See the manual for the disc.

Fast Forward/Reverse

- You cannot perform Fast Forward/Fast Reverse between titles. At the end or beginning of the title, Fast Forward/Fast Reverse will be cancelled and normal playback will automatically resume.
- Subtitles are not played back with BD/DVD video discs during Fast Forward and Fast Reverse.
- Depending on the disc and the scene being played back, the Player may not operate at the speed listed in this manual when performing Fast Forward.

Slow Playback

- You cannot perform Slow Playback between titles. At the end of the title, Slow Playback will be cancelled and normal playback will automatically resume.

Repeat Playback

- Repeat Playback may be forbidden depending on the disc.
- Partial Repeat Playback may not work in multi-angle scenes.
- For Partial Repeat Playback, set the start and end points within the same title.

Settings During Playback

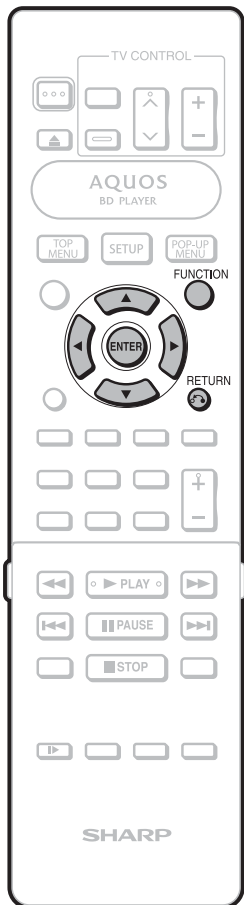

Function Control

This allows you to adjust various settings at once, like subtitles, angle settings and the title selection for Direct Playback. You can adjust the video and audio to suit your preferences. The operations are the same for BD and DVD.

Function control screen

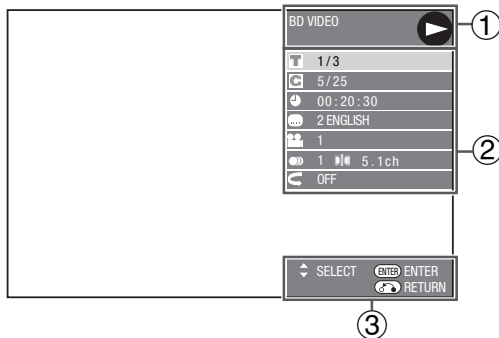

- ① **Playback status display**
Shows the operation status and the disc type.
- ② **Setting items**
Selects a title or chapter for playback, or performs video/audio settings.
- ③ **Operation guide display**
Provides help on remote control button operations.

Function control operation procedure

- 1 Press **FUNCTION** during playback.
 - The Function Control screen is displayed on the TV.

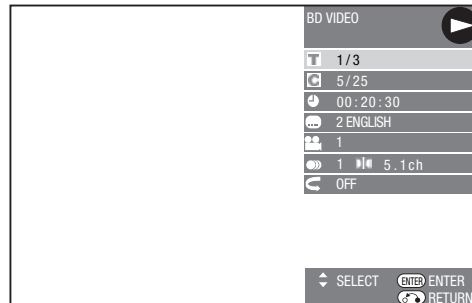

- 2 Press **▲/▼** to select the desired setting, then press **ENTER**.
 - For a description of each setting, see "Functions which can be set". (Page 32)

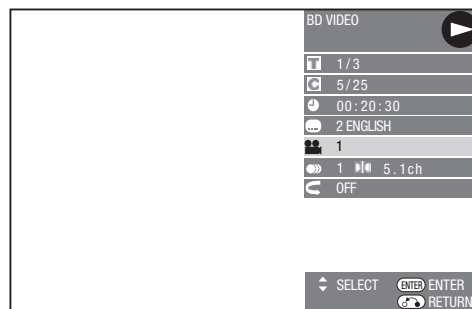

- 3 Press **▲/▼/◀▶** to set, then press **ENTER**.
 - Operations vary depending on the setting. Follow the operation instructions on the screen.
- 4 Press **RETURN** or **FUNCTION** to close the Function Control screen.

- NOTE**
- If "--" is displayed for an option like title number or subtitles, the disc has no titles or subtitles which can be selected.
 - The displayed items vary depending on the disc.
 - If you access the Function Control screen during playback of a BD/DVD video, it may be impossible to operate the BD/DVD video playback. In cases like this, close the Function Control screen.



Functions which can be set

Title Number (Direct Title Skip)

- Shows the title number being played back. You can skip to the start of the title.
- To skip to the start of a selected title, press the **Number** buttons to enter the title number when this option is highlighted.

Chapter Number (Direct Chapter Skip)

- Shows the chapter number being played back. You can skip to the start of the chapter.
- To skip to the start of a selected chapter, press the **Number** buttons to enter the chapter number when this option is highlighted.

Playback Elapsed Time (Direct Time Skip)

- Shows the elapsed time from the beginning of the disc to the present. This lets you skip to a specific time.
- Press ◀▶ to select the Hour, Minute or Second, then press ▲/▼ or the **Number** buttons to set the time. Press **ENTER** to start playback at the set time.

NOTE

- **ENTER** button under the Cover: Enters the input number.
- **CLEAR** button under the Cover: Clears the input number.

Subtitle Language

- Shows the currently selected subtitle language. If subtitles are provided in other languages, you can switch to your preferred language.

Angle Number

- Shows the currently selected angle number. If the video is recorded with multiple angles, you can switch the angle.

Audio

- Shows the currently selected type of audio. You can select the desired type of audio.

Repeat

- The current Title (or Chapter) or partial segments can be repeatedly played back. Repeat Playback is also possible with the **REPEAT** button on the remote control.

NOTE

- These functions may not work with all discs.

SETTINGS

AUDIO VIDEO SETTINGS

TV ASPECT RATIO

- If you switch your TV (i.e. because you have bought a new one) and the screen aspect ratio of the connected TV changes, you will have to change the "TV ASPECT RATIO" setting.
- You can set the screen aspect ratio of the connected TV, and adjust the video output.
- Select "TV ASPECT RATIO" from "AUDIO VIDEO SETTINGS".

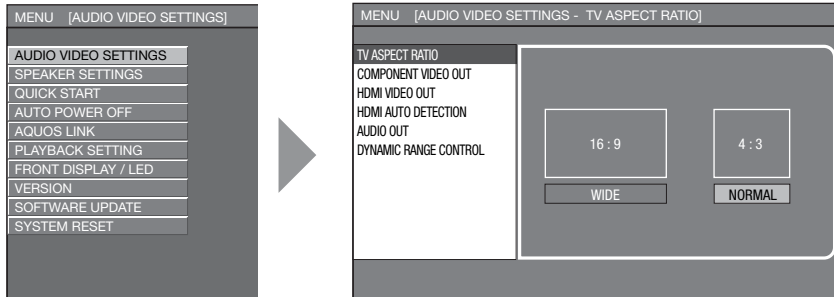

WIDE 16:9: Select this when connecting to a TV with a 16:9 screen aspect ratio.
NORMAL 4:3: Select this when connecting to a TV with a 4:3 screen aspect ratio.

WIDE 16:9
NORMAL 4:3

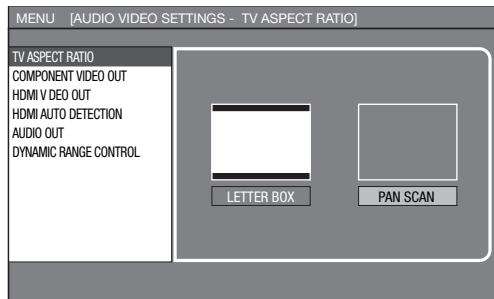

<When selecting NORMAL 4:3>

LETTER BOX: If you connect to a TV with a screen aspect ratio of 4:3 and playback a DVD with 16:9 video, the video will be played back with black bands at the top and bottom while maintaining the 16:9 ratio.

PAN SCAN: If you connect to a TV with a screen aspect ratio of 4:3 and playback a DVD with 16:9 video, the video will be played back with the left and right sides of the image cut off to display in 4:3 screen aspect ratio. (This function works if the disc is labelled for 4:3PS.)

LETTER BOX,
PAN SCAN

COMPONENT VIDEO OUT

- This sets the resolution of the component video output.

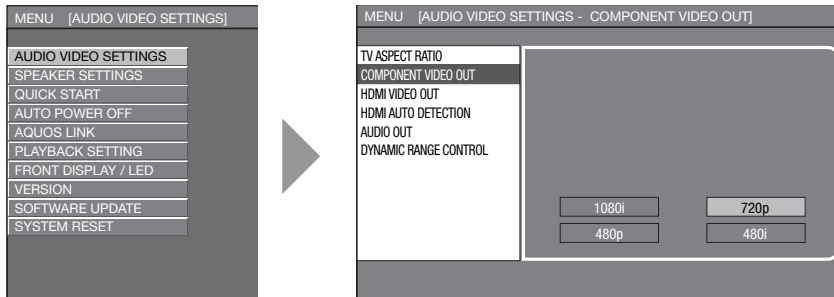

1080i, 720p,
480p, 480i

- Some TV are not fully compatible with the Blu-ray disc player, which may cause the image distortion. In this case, press "COMPONENT RESET" on the remote control for five seconds. Component video out will be reset to 480i (factory preset value).

Caution: HDMI output and Component output can not be used at the same time.

HDMI VIDEO OUT

- This sets the resolution of the HDMI video output.

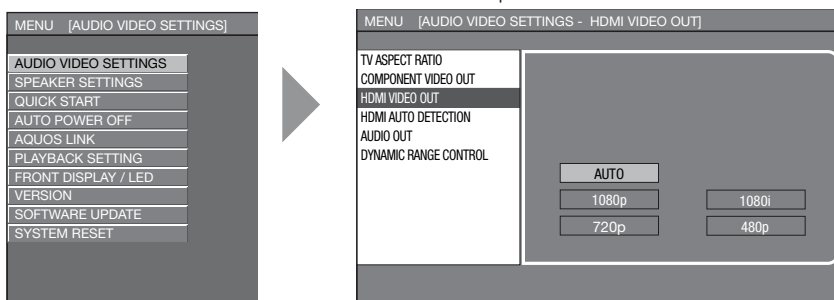

AUTO,
1080p, 1080i,
720p, 480p

Caution: HDMI output and Component output can not be used at the same time.

NOTE

- When the BD player is connected to a 1080p 24Hz compatible TV and the HDMI VIDEO OUT is set to AUTO, 1080p 24Hz will automatically be displayed when compatible discs are played back.

SETTINGS

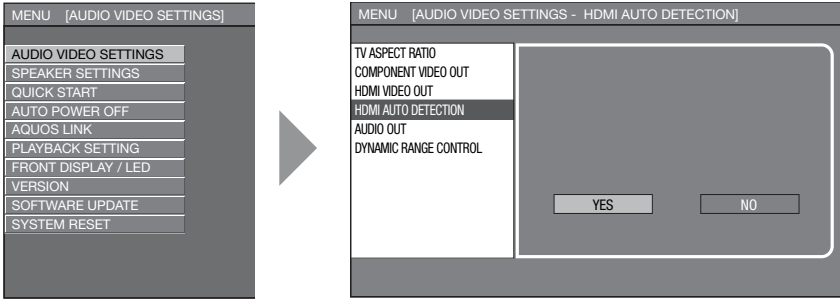
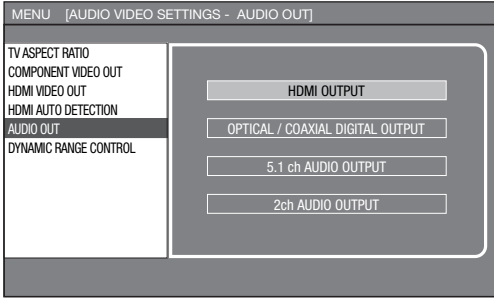
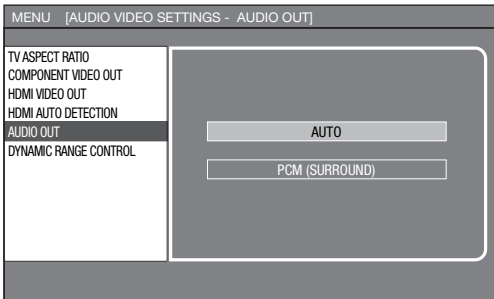
<p>HDMI AUTO DETECTION</p> <ul style="list-style-type: none"> This automatically sets the player's video output to HDMI when it detects this signal. 	<p>YES, NO</p>										
<p>AUDIO OUT</p> <ul style="list-style-type: none"> You can set AUDIO OUT when connecting to SURROUND sound equipment. 1. This sets the audio output connected to SURROUND equipment. 	<p>HDMI OUTPUT</p> <p>OPTICAL/ COAXIAL DIGITAL OUTPUT</p> <p>5.1ch AUDIO OUTPUT</p> <p>2ch AUDIO OUTPUT</p>										
<table border="1"> <thead> <tr> <th>Selected item</th> <th>Description</th> </tr> </thead> <tbody> <tr> <td>HDMI OUTPUT</td> <td>Select this when you connect using HDMI OUT terminal.</td> </tr> <tr> <td>OPTICAL/COAXIAL DIGITAL OUTPUT</td> <td>Select this when you connect using DIGITAL AUDIO OUT terminal (COAXIAL or OPTICAL).</td> </tr> <tr> <td>5.1ch AUDIO OUTPUT</td> <td>Select this when you connect using 5.1CH AUDIO OUT jacks.</td> </tr> <tr> <td>2ch AUDIO OUTPUT</td> <td>Select this when you do not use SURROUND sound equipment.</td> </tr> </tbody> </table>	Selected item	Description	HDMI OUTPUT	Select this when you connect using HDMI OUT terminal.	OPTICAL/COAXIAL DIGITAL OUTPUT	Select this when you connect using DIGITAL AUDIO OUT terminal (COAXIAL or OPTICAL).	5.1ch AUDIO OUTPUT	Select this when you connect using 5.1CH AUDIO OUT jacks.	2ch AUDIO OUTPUT	Select this when you do not use SURROUND sound equipment.	
Selected item	Description										
HDMI OUTPUT	Select this when you connect using HDMI OUT terminal.										
OPTICAL/COAXIAL DIGITAL OUTPUT	Select this when you connect using DIGITAL AUDIO OUT terminal (COAXIAL or OPTICAL).										
5.1ch AUDIO OUTPUT	Select this when you connect using 5.1CH AUDIO OUT jacks.										
2ch AUDIO OUTPUT	Select this when you do not use SURROUND sound equipment.										
<p>2. You can set the audio output mode for each output terminal.</p> <p>① This sets the audio output mode for HDMI OUT terminal when selecting HDMI OUTPUT.</p> 	<p>AUTO</p> <p>PCM (SURROUND)</p>										
<table border="1"> <thead> <tr> <th>Selected item</th> <th>Description</th> </tr> </thead> <tbody> <tr> <td>AUTO</td> <td> <ul style="list-style-type: none"> Select this when connecting to HDMI equipment with a built-in decoder for DOLBY DIGITAL, etc. Setting to AUTO will output in an audio output mode best suited to the connected equipment. </td> </tr> <tr> <td>PCM (SURROUND)</td> <td> <ul style="list-style-type: none"> Select this when connecting to multi-channel HDMI equipment. Setting to PCM (SURROUND) will output by LINEAR PCM by decoding audio signals recorded in each audio output mode such as DOLBY DIGITAL, DTS, AAC. </td> </tr> </tbody> </table>	Selected item	Description	AUTO	<ul style="list-style-type: none"> Select this when connecting to HDMI equipment with a built-in decoder for DOLBY DIGITAL, etc. Setting to AUTO will output in an audio output mode best suited to the connected equipment. 	PCM (SURROUND)	<ul style="list-style-type: none"> Select this when connecting to multi-channel HDMI equipment. Setting to PCM (SURROUND) will output by LINEAR PCM by decoding audio signals recorded in each audio output mode such as DOLBY DIGITAL, DTS, AAC. 					
Selected item	Description										
AUTO	<ul style="list-style-type: none"> Select this when connecting to HDMI equipment with a built-in decoder for DOLBY DIGITAL, etc. Setting to AUTO will output in an audio output mode best suited to the connected equipment. 										
PCM (SURROUND)	<ul style="list-style-type: none"> Select this when connecting to multi-channel HDMI equipment. Setting to PCM (SURROUND) will output by LINEAR PCM by decoding audio signals recorded in each audio output mode such as DOLBY DIGITAL, DTS, AAC. 										

② This sets the audio output mode for DIGITAL AUDIO OUT (COAXIAL jack / OPTICAL terminal) when selecting **OPTICAL/COAXIAL DIGITAL OUTPUT** or **2ch AUDIO OUTPUT**

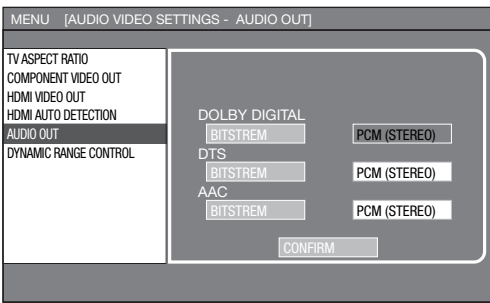

DOLBY DIGITAL

DTS
AAC

BITSTREAM
PCM
(STEREO)

Selected item		Description
DOLBY DIGITAL	BITSTREAM	<ul style="list-style-type: none"> Select this when connecting to SURROUND equipment with a built-in decoder for DOLBY DIGITAL, DTS, AAC. Setting to BITSTREAM will output each audio signal by BITSTREAM.
DTS		
AAC	PCM (STEREO)	<ul style="list-style-type: none"> Select this when connecting to 2 channel stereo audio equipment. Setting to PCM (STEREO) will output by converting each audio signal into PCM 2channel audio signal.

DYNAMIC RANGE CONTROL

- This lets you adjust the range between the loudest and softest sounds (dynamic range) for playback at average volume. Use this when it is hard to hear dialogue.

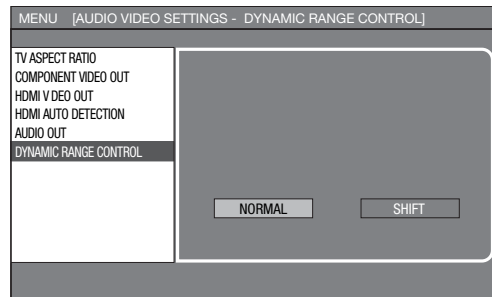
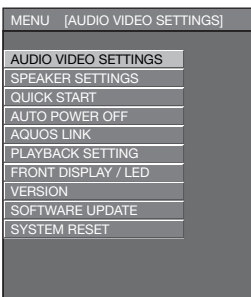

NORMAL*: The some audio output range is played as the original recorded audio output range.

SHIFT: When Dolby Digital audio is played back, the dynamic range of the audio is adjusted so that the dialogue portion can be heard easily. (If the audio sounds abnormal, set to "NORMAL".)

SHIFT,
NORMAL

* Lower the audio volume before setting. If you do not do so, the speakers may emit a loud sound or excessive output may be applied to the speakers.

SETTINGS

Basic Operation for AUDIO VIDEO SETTINGS

Example: Setting "TV ASPECT RATIO" under "AUDIO VIDEO SETTING"

- 1 Press **SETUP** to display the SETUP MENU screen.
- 2 Press **▲/▼/◀/▶** to select "SETTINGS", then press **ENTER**.

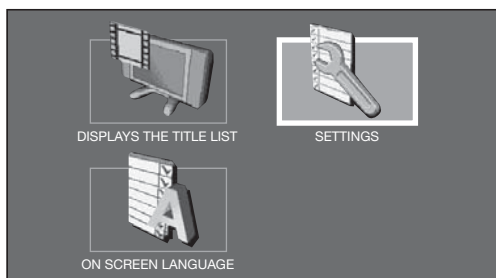

- 3 Press **▲/▼** to select "AUDIO VIDEO SETTINGS", then press **ENTER**.

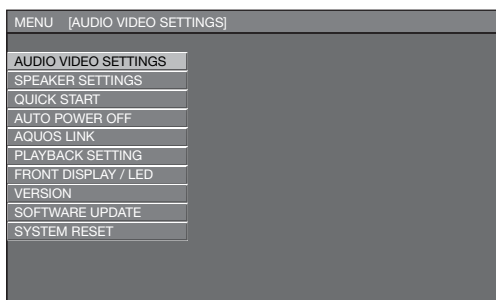

- 4 Press **▲/▼** to select "TV ASPECT RATIO", then press **ENTER**.
- 5 Press **◀/▶** to select the desired item, then press **ENTER**.

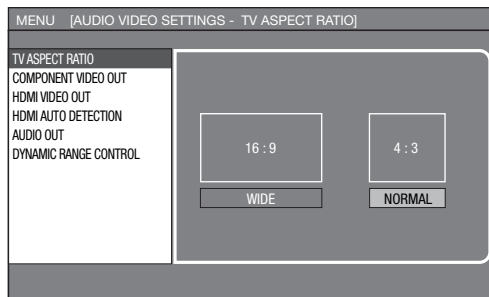

- 6 Press **◀/▶** to select the desired format, then press **ENTER**.

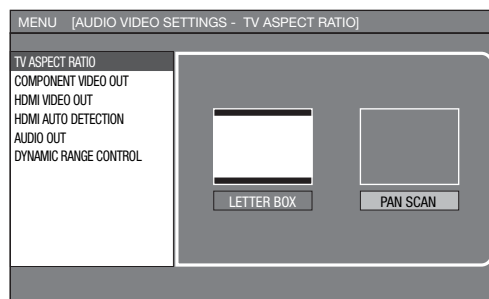

- 7 Press **SETUP** or **EXIT** to exit.

SPEAKER SETTINGS

About speakers

You can use your speakers with this Player through an amplifier. You can set the speaker size, distance from the viewer, and output level for each speaker.

Using multi channel speakers

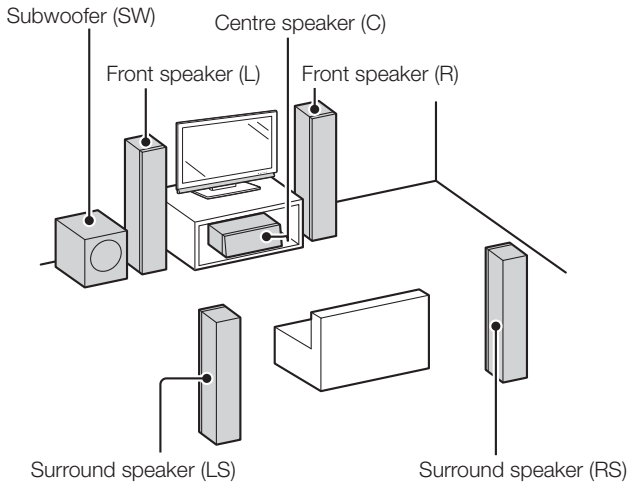

Using 2 channel speakers

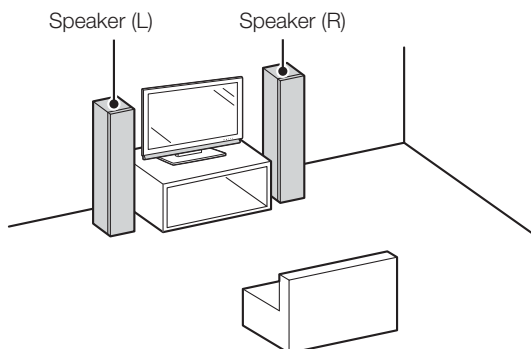

NOTE

- Refer to the operation manual for the speakers or amplifier for details of speaker setup.
- Speaker setting cannot be performed with the disc in the disc tray. Take out the disc from the player before setup.

Basic Operation for SPEAKER SETTINGS

- 1 Press **SETUP** to display the SETUP MENU screen.
- 2 Press **▲/▼/◀/▶** to select "SETTINGS", then press **ENTER**.

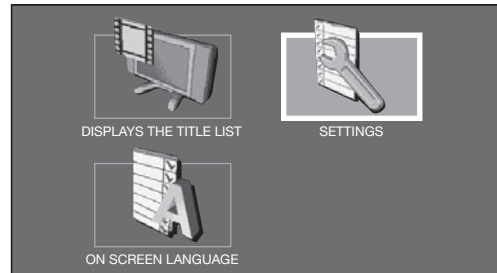

- 3 Press **▲/▼** to select "SPEAKER SETTINGS", then press **ENTER**.

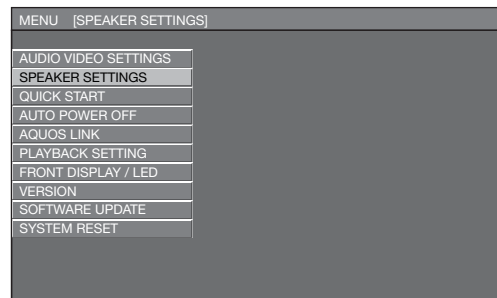

- 4 Press **◀/▶** to select the desired item, then press **ENTER**.

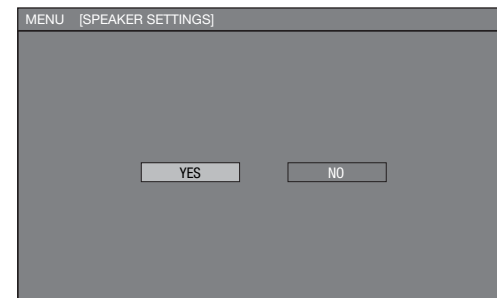

SETTINGS

- 5 Press **▲/▼/◀▶** to select the speaker, then press **ENTER**.

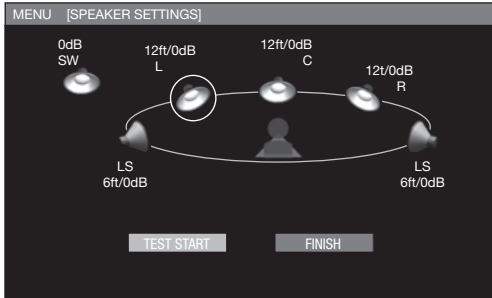

- 6 Press **◀▶** to select the preferred item, then press **▲/▼** to select the preferred setting, then press **ENTER**.

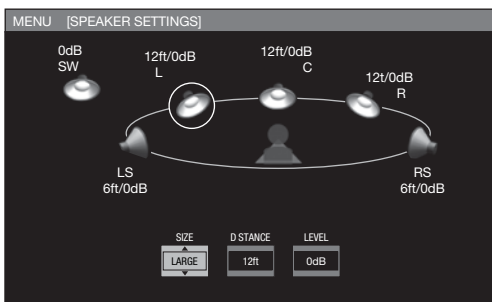

Speakers	Selectable size
L/R	LARGE*, SMALL
C/RS/LS	LARGE*, SMALL, NONE
SW	YES*, NO
* Factory preset	
LARGE: The cone diameter is 6.3 inches or larger. SMALL: The cone diameter is smaller than 6.3 inches.	
Selectable Distance range	1ft through 29ft (Settings available in 1ft increments) The factory preset value: 12ft(L/R/C) 6ft(RS/LS)
Selectable Output Level range	-6dB through +6dB (Settings available in 1dB increments) The factory preset value is 0dB.

- 7 Repeat steps 5 and 6 until each speaker's size, and level are set.

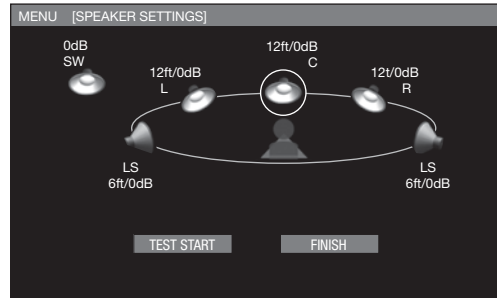

NOTE

- The speakers L and R, LS and RS move relative to one another.
- The speakers L and R are automatically set to "LARGE" when the subwoofer SW is set to "NO", even after speakers L and/or R are set to "SMALL".
- The images of speakers set to "NONE" disappear or are greyed out on the screen.
- As for a subwoofer, there are no settings for distance only for level.

Checking the setup sound

- 8 Press **▲/▼/◀▶** to select "TEST START", then press **ENTER**.

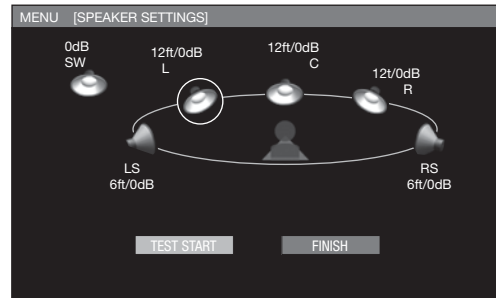

- After switching to TEST mode, you can hear the Test sound from each speaker in turn.
- If you press **▲/▼/◀▶** to select the preferred speaker while the TEST sound is present, you can hear the TEST sound of the speaker that you selected.
- If you press **▲/▼/◀▶** to select "TEST TONE STOP" and press **ENTER**, you can stop the Test sound

Resetting the setup

- When the sound volume of each speaker is uneven, reset the settings separately.
- As for a subwoofer, you can adjust LEVEL only.

9 Press **ENTER** while the TEST sound is present from the speaker that you want to reset the setting.

10 Press **◀/▶** to select the “LEVEL”, then press **▲/▼** to preferred setting, then press **ENTER**.

11 Repeat steps 9 and 10 until each speaker is reset.

Completing the settings

12 Press **▲/▼/◀/▶** to select “FINISH”, then press **ENTER**.

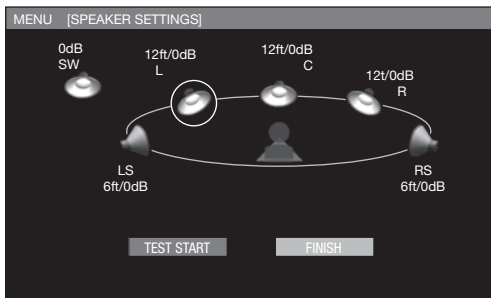

13 Press **SETUP** or **EXIT** to exit.

SETTINGS

QUICK START

- This turns the QUICK START function on and off.
- When the QUICK START function is on, the startup time of the player is reduced when resuming playback from standby.
- However, power consumption will increase.

YES, NO

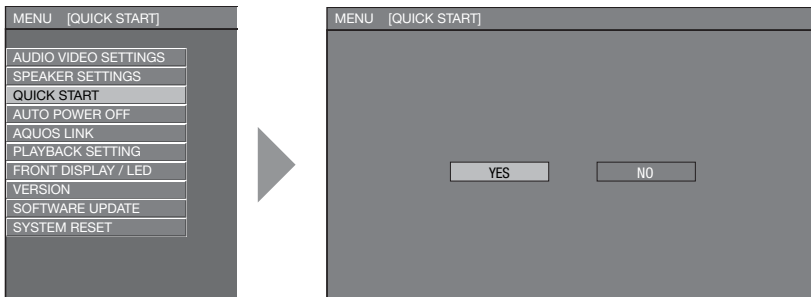

AUTO POWER OFF

- This sets the Player so that power is automatically shut off if playback is stopped for about 10 minutes.

YES, NO

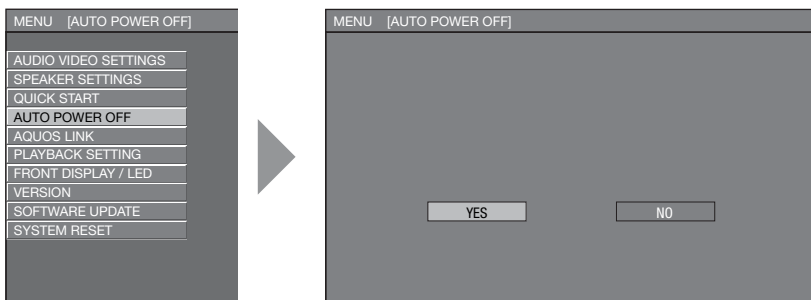

AQUOS LINK

- This lets you set the Player to receive the control signal from the AQUOS LINK remote control via the HDMI cable.

YES, NO

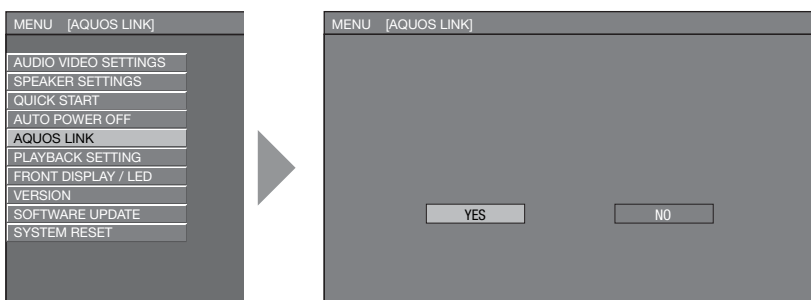

- For details, refer to the operation manual of TV.

PLAYBACK SETTING

PARENTAL CONTROL

- This lets you set the Parental Control depending on the disc content.
- For DVD-video:
8 and OFF: All DVD-video can be played.
1-7: Prohibits play of DVD-video with corresponding ratings recorded on them.
- For BD-ROM:
NO LIMIT: All BD-video can be played.
0-99 year(s): Prohibits play of BD-video with corresponding ratings recorded on them.
- Parental Control Level cannot be set if a password has not been set.

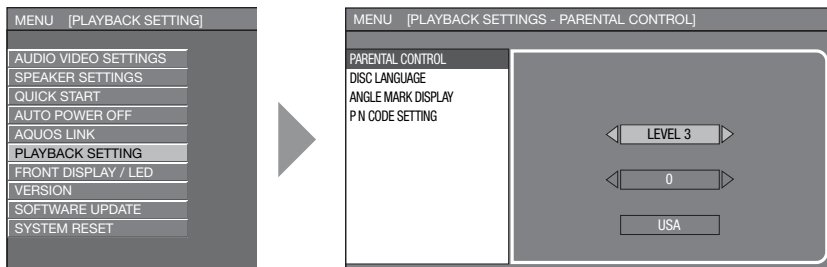

- Refer to “Basic Operation for PLAYBACK SETTING” on page 43 for details.

For DVD video:
OFF,
LEVEL 1-8

For BD - ROM:
NO LIMIT.
LEVEL 0-99

COUNTRY CODE
* Refer to the Country Code List. (Page 42)

DISC LANGUAGE (DISC PRIORITY LANGUAGE)

- This lets you select the language for subtitles, audio and menus displayed on the screen.

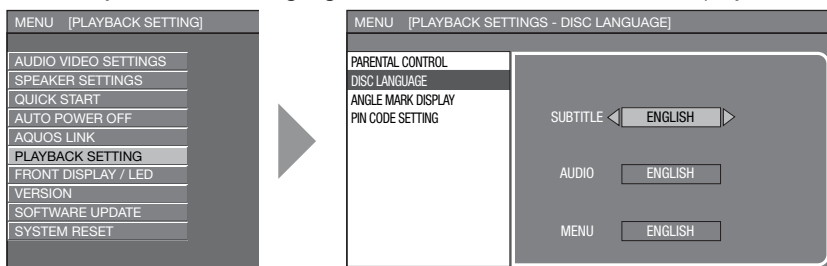

SUBTITLE,
AUDIO,
MENU
* Refer to the Language Code List. (Page 42)

ANGLE MARK DISPLAY

- This lets you turn the Angle Mark Display on or off when DVD video recorded with multiple angles is played back. (The Angle Mark is displayed in the lower right screen.)

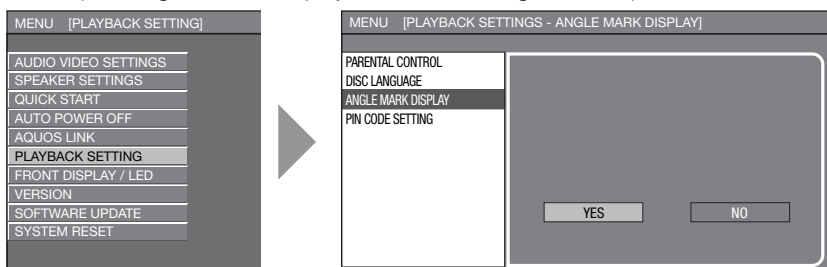

YES, NO

PIN CODE SETTING

- This sets the password for setting or changing the Parental Control Level.

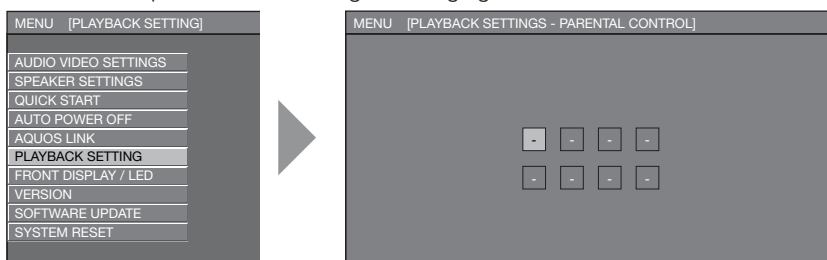

YES, NO
4 digit number

NOTE

- When you forget the PIN code, you can reset the current PIN code using SYSTEM RESET under SETTINGS. (p.44)
You can also set the new PIN code if desired.

SETTINGS

Country Code List

USA	UK	HOLLAND	HONG KONG	TAIWAN
CANADA	ITALY	NORWAY	SINGAPORE	PHILIPPINE
JAPAN	SPAIN	DENMARK	THAILAND	AUSTRALIA
GERMANY	SWISS	FINLAND	MALAYSIA	RUSSIA
FRANCE	SWEDEN	BELGIUM	INDONESIA	CHINA

Language Code List

AA Afar	EU Basque	KK Kazakh	OM Afan (Oromo)	SW Swahili
AB Abkhazian	FA Persian	KL Greenlandic	OR Oriya	TA Tamil
AF Afrikaans	FI Finnish	KM Cambodian	PA Panjabi	TE Telugu
AM Ameharic	FJ Fiji	KN Kannada	PL Polish	TG Tajik
AR Arabic	FO Faroese	KO Korean	PS Pashto, Pushto	TH Thai
AS Assamese	FR French	KS Kashmiri	PT Portuguese	TI Tigrinya
AY Aymara	FY Frisian	KU Kurdish	QU Quechua	TK Turkmen
AZ Azerbaijani	GA Irish	KY Kirghiz	RM Rhaeto-Romance	TL Tagalog
BA Bashkir	GD Scots Gaelic	LA Latin	RN Kirundi	TN Setswana
BE Byelorussian	GL Galician	LN Lingala	RO Romanian	TO Tonga
BG Bulgarian	GN Guarani	LO Laothian	RU Russian	TR Turkish
BH Bihari	GU Gujarati	LT Lithuanian	RW Kinyarwanda	TS Tsonga
BI Bislama	HA Hausa	LV Latvian, Lettish	SA Sanskrit	TT Tatar
BN Bengali, Bangla	HI Hindi	MG Malagasy	SD Sindhi	TW Twi
BO Tibetan	HR Croatian	MI Maori	SG Sangho	UK Ukrainian
BR Breton	HU Hungarian	MK Macedonian	SH Serbo-Croatian	UR Urdu
CA Catalan	HY Armenian	ML Malayalam	SI Singhalese	UZ Uzbek
CO Corsican	IA Interlingua	MN Mongolian	SK Slovak	VI Vietnamese
CS Czech	IE Interlingue	MO Moldavian	SL Slovenian	VO Volapük
CY Welsh	IK Inupiak	MR Marathi	SM Samoan	WO Wolof
DA Danish	IN Indonesian	MS Malay	SN Shona	XH Xhosa
DE German	IS Icelandic	MT Maltese	SO Somali	YO Yoruba
DZ Bhutani	IT Italian	MY Burmese	SQ Albanian	ZH Chinese
EL Greek	IW Hebrew	NA Nauru	SR Serbian	ZU Zulu
EN English	JA Japanese	NE Nepali	SS Siswat	
EO Esperanto	JI Yiddish	NL Dutch	ST Sesotho	
ES Spanish	JW Javanese	NO Norwegian	SU Sundanese	
ET Estonian	KA Georgian	OC Occitan	SV Swedish	

Basic Operation for PLAYBACK SETTING

Example: Setting "PARENTAL CONTROL" under "PLAYBACK SETTING".

- 1 Press **SETUP** to display the SETUP MENU screen.
- 2 Press **▲/▼/◀/▶** to select "SETTINGS", then press **ENTER**.

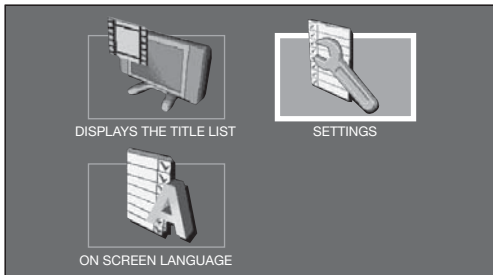

- 3 Press **▲/▼** to select "PLAYBACK SETTING", then press **ENTER**.

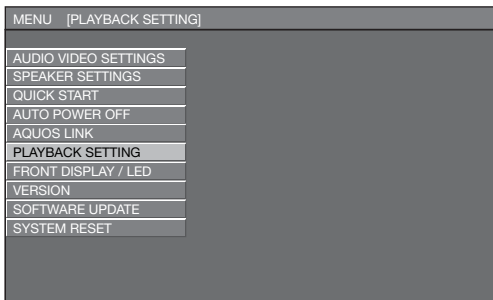

When setting the password for the first time.

1. Press **◀/▶** to select "YES" to enter the password setting menu, then press **ENTER**.
 2. Enter the 4-digit number.
 3. Press **ENTER** to move to the next setting screen.
- 4 Press **▲/▼** to select "PARENTAL CONTROL", then press **ENTER**.
 - 5 Enter your password.
 - You cannot move to the next setting screen until you can input the correct password.

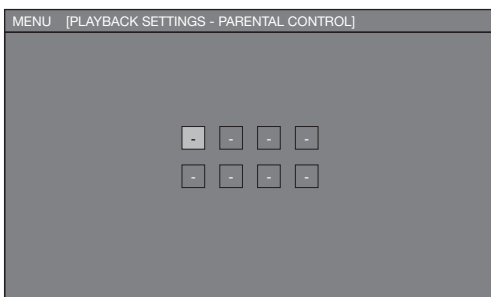

- 6 Press **◀/▶** to select parental control level for DVD video, then press **ENTER**. Press **◀/▶** to select parental control level for BD-ROM, then press **ENTER**. Press **◀/▶** to select the country code, then press **ENTER**.

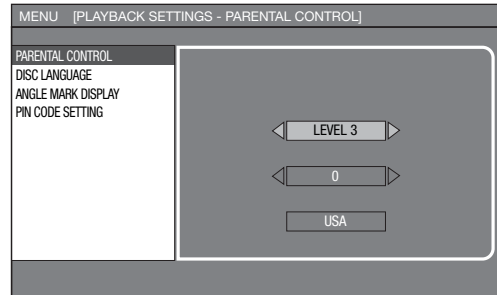

- 7 Press **SETUP** or **EXIT** to exit.

SETTINGS

FRONT DISPLAY/LED

- If you feel that the indicators on the Player are too bright when watching movies, you can turn them off except for the ON indicator.

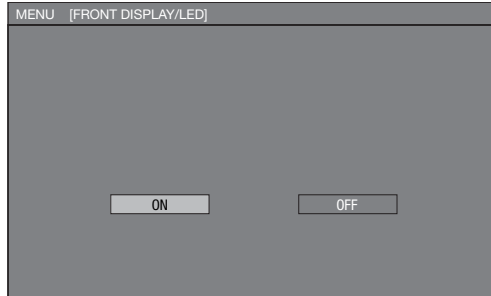
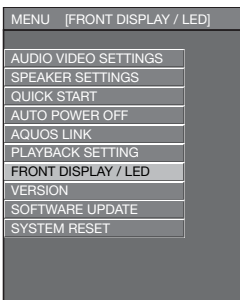

ON, OFF

VERSION

- When you select "VERSION", the system software version is displayed.

SYSTEM RESET

- You can reset all settings except the password to the factory presets.

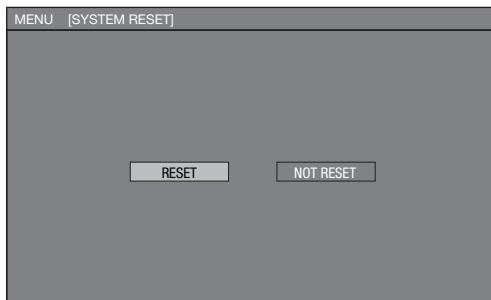
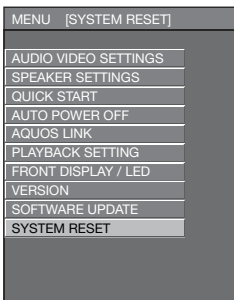

RESET,
NOT RESET

Common operation

Example: Setting "FRONT DISPLAY/LED"

- Press **SETUP** to display the SETUP MENU screen.
- Press **▲/▼/◀/▶** to select "SETTINGS", then press **ENTER**.

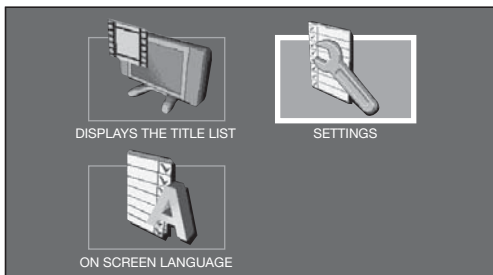

- Press **▲/▼** to select "FRONT DISPLAY/LED", then press **ENTER**.

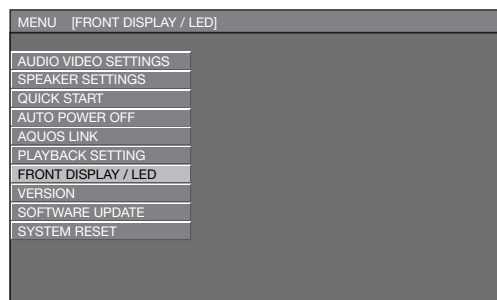

- Press **◀/▶** to select the desired item, then press **ENTER**.

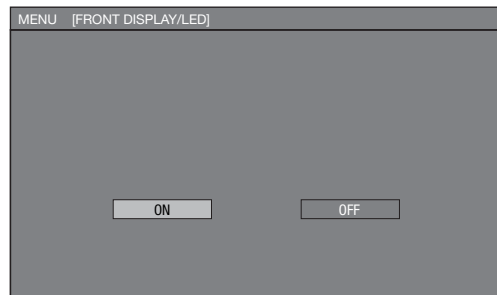

- Press **SETUP** or **EXIT** to exit.

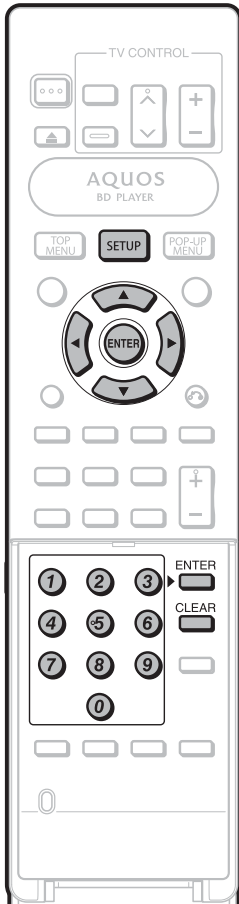

SOFTWARE UPDATE

This function allows software updates by inserting a USB memory device with the update file into the SERVICE terminal on this player.

Regarding how to obtain the software update file, please call 1-800-BE-SHARP.

CAUTION

- Do not remove the USB memory device or unplug the AC cord while the software is being updated.

- 1 Insert the USB memory device with the update file into the **SERVICE** terminal on rear of this player.
- 2 Press **SETUP** to display the SETUP MENU screen.
- 3 Press **▲/▼/◀/▶** to select “SETTINGS”, then press **ENTER**.
- 4 Press **▲/▼** to select “SOFTWARE UPDATE”, then **ENTER**.
 - If you already set the password, go to step 6.

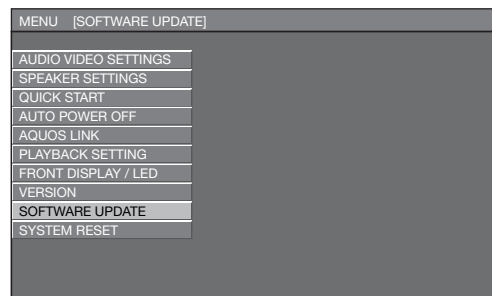

- 5 Enter the 4-digit number using 0-9.

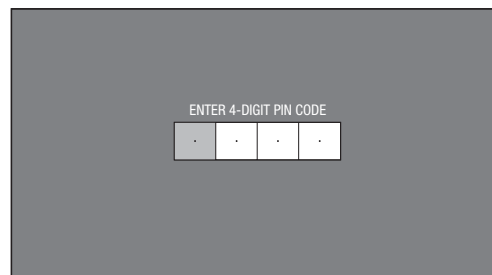

- 6 Press **ENTER** to start checking data in the USB memory device.



- 7 During the data checking, “Checking” blinks.

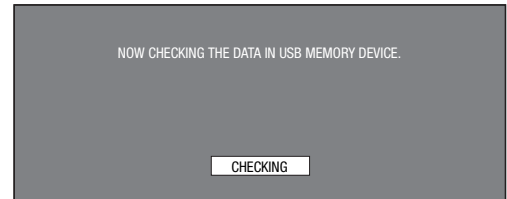

- The current version of this unit software and the version of the update file on the USB memory device are displayed. To update this player software with update file, select “YES”, and press **ENTER**.

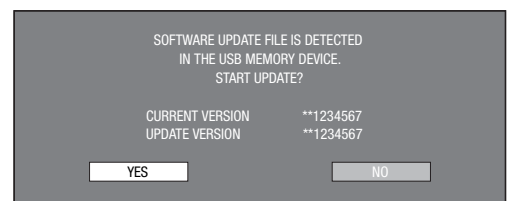

- If the USB memory device is not properly installed or the correct update file cannot be found on the USB memory device, an error message is displayed. Check the file on the USB memory device, and then reinsert the USB memory device correctly.



SETTINGS

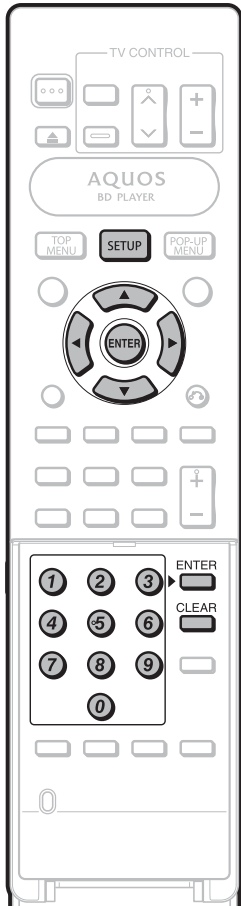

- 8** Press **ENTER** to start updating.
- The screen becomes dark for a while until the update screen can be displayed. Please wait for the update screen to appear. Do not unplug the AC cord.

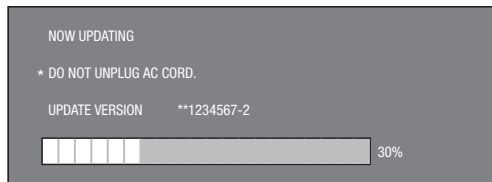
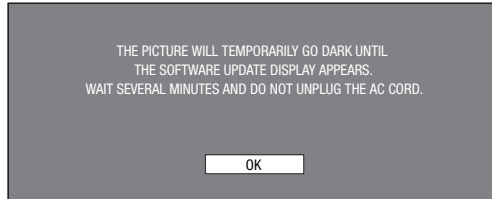

- 9** When the software is successfully updated, a screen is displayed indicating that the update process is completed. After this screen is displayed, the unit automatically turns off and then turns on again.



- If the update has failed, check the file in the USB device and try Software Update again.

- 10** The message "SYSTEM SOFTWARE WAS SUCCESSFULLY UPDATED" is displayed, and then press **ENTER** .

- 11** Remove the USB memory device.

Troubleshooting

The following problems do not always suggest a defect or malfunction of this Player. Refer to the problems and lists of possible solutions below before calling for service.

The Player power cannot be turned on.

- Is the power cord firmly plugged into the AC outlet?
- When the power cord is plugged into an AC outlet, press and hold POWER on the Player until "RESET" appears on the front panel display. Then, after the STANDBY indicator is lit, turn on the power. (Page 48)
- Press POWER after the STANDBY indicator turns on.

The disc is automatically ejected after closing the disc tray.

- Make sure that the disc is loaded properly (aligned in disc tray and label-side up).
- Take out the disc and clean it.
- Make sure that region code on the disc matches that of this Player.
- Make sure that the disc is playable.

No picture.

- Make sure that the cables are connected correctly.
- Make sure that the connected TV or the AV receiver is set to the correct input.
- Take out the disc and clean it.
- Make sure that region code on the disc matches that of this Player.
- There is no picture from the HDMI output.
 - Are the settings performed correctly? Please check the settings.
- There is no picture from the Component output.
 - Are the settings performed correctly? Please check the settings.

The Player cannot play a disc.

- Take out the disc and clean it.
- Make sure that the disc is loaded properly (aligned in disc tray and label-side up).
- Make sure that region code on the disc matches that of this Player.
- Allow any condensation in or near the Player to dry.
- Check that the disc is recorded in the compatible TV system (PAL or NTSC).
- The Player cannot play back video which was not recorded normally.
- Proper playback may be impossible due to the state of the disc recording, a scratched, warped or dirty disc, the state of the pick-up, or compatibility issues between this Player and the disc being used.
- When the recorded time of a disc is unusually short, playback may not be possible.

The settings have been erased.

- If the Player is unplugged (or there is a power failure) for more than about 1 hour while its power is on, the settings will be lost. Make sure that you turn off the Player before unplugging the power cord.
- When there is a power interruption or the power cord is unplugged from the power outlet with the power on, all settings return to the factory preset values.

The Player power is turned off.

- Is "AUTO POWER OFF" set to "YES"? When "AUTO POWER OFF" is set to "YES", the power will be automatically turned off after 10 continuous minutes of inactivity (no playback).

Screen freezes and operation buttons do not work.

- Press **STOP**, then restart playback.
- Turn off the power and turn on the power again.
- If the power is not turned off, perform a reset. (Page 48)
- Is the disc damaged or dirty? Check the condition of the disc. See page 10 for details about disc cleaning.

The remote control does not work.

- Set the remote control and the Player to the same remote control code. (Page 21)
- Use the remote control within its operating range.
- Replace the batteries.

No sound, or sound is distorted.

- If the volume of the TV or amplifier is set to minimum, turn the volume up.
- There is no sound during still mode, slow motion playback, fast forward and fast reverse.
- DVD audio recorded in DTS is only output from the DIGITAL AUDIO OUT terminal or jack. Connect a DTS compatible digital amplifier or decoder to the DIGITAL AUDIO OUT OPTICAL terminal or COAXIAL jack on this Player.
- Check that the audio cable is connected correctly.
- Check that the cable plugs are clean.
- Take out the disc and clean it.
- Audio may not be output depending on the audio recording status, such as when audio other than an audio signal or non-standard audio is recorded for the audio content of the disc.

The playback screen will be disturbed if DVD video is recorded to a VCR, or played back through a VCR.

- This Player complies with analogue copy protection. Some discs contain a copy prohibiting signal. If you try to play back such discs through a VCR, or record to a VCR and play back the signal, the copy protection will prevent normal playback.

The TV operates incorrectly.

- Some TVs with wireless remote control capability may operate incorrectly when using the remote control of this Player. Use such TVs away from this Player.

There is just audio with no video.

- Is the connection cable for video output connected properly?

Widescreen video appears vertically stretched, or black bands appear at the top and bottom of the screen.

- Is "TV ASPECT RATIO" set to match the connected TV? (Page 33)
- If you are using a widescreen TV, is the "TV ASPECT RATIO" set to "WIDE"? (Page 33)

Troubleshooting

Square noise (mosaic) appears on the screen.

- Blocks in images may be visible in scenes with rapid movement due to the characteristics of digital image compression technology.

Video stops.

- Has the Player been subjected to shock or impact? Are you using it in an unstable location? The Player will stop if it senses shock or vibration.

Left and right channels of audio are reversed, or sound comes out of only one side.

- Are left and right audio cables connected to the opposite terminal, or is one side disconnected?

Disc does not play back automatically.

- Have you set a disc that has an automatic playback function?

The Player heats up during use.

- When using this Player, the console cabinet may heat up depending on the usage environment. This is not a malfunction.

The Player makes a snapping sound when starting playback or loading a disc.

- The player may sometimes make a snapping sound when starting playback if it has not been operated in a while. These sounds are not malfunctions of the player but are normal operating conditions.

Cannot operate the Player.

- Are you operating the Player within the specified operating temperature range? (Page 52)

STANDBY indicator will remain lit.

- When the AC cord is removed from the outlet, the STANDBY indicator will remain lit for a short period. This is normal and is not a malfunction.

NOTE

Reset

- If this Player receives strong interference from a source such as excessive static electricity, strong external noise, malfunction of power supply, or voltage caused by lightning during use or a wrong operation is sent to the Player, errors like the Player not accepting an operation may occur. Press and hold POWER on the Player until "R E S E T" appears on the front panel display when the Player does not operate properly even after the power has been turned off. Then, after the STANDBY indicator is lit, turn on the power.
 - When a reset is performed while the power is on, the Player will turn off. Turn the power on again. At this point, it may take a few moments for the system processing to finish before the Player is ready for use. During the system processing, the BD and DVD/CD mode indicators on the front panel display of the Player will blink. Once the system processing has finished, the indicators will finish blinking and then light up normally. You can operate the Player when the BD and DVD/CD mode indicators are lit.
 - Since all settings including the language setting stored in memory are also reset when a reset has been performed, they must be set again.
 - When the problem persists even after performing a reset, unplug the AC cord and plug it in again. If this does not solve the problem, contact the nearest service center approved by SHARP.
-

On-screen Error Messages

Messages Relating to BD and DVD

- The following messages appear on the TV screen in case the disc you tried to playback is not appropriate or the operation is not correct.

Error message	Possible Error	Suggested Solution
CANNOT PLAY.	<ul style="list-style-type: none">• The disc cannot be played back with this Player.	<ul style="list-style-type: none">• Check the disc, and load it correctly.
INCOMPATIBLE DISC.	<ul style="list-style-type: none">• If you load a disc which cannot be played with this Player (i.e. a scratched disc), or if you load a disc upside down, this message will appear, and the disc tray will automatically pop out.	
	<ul style="list-style-type: none">• Occurs if the loaded disc cannot be played because it is a non-standard disc or scratched, etc.	<ul style="list-style-type: none">• Remove the disc.
CANNOT OPERATE.	<ul style="list-style-type: none">• Occurs if an operation is incorrect.	_____

Glossary

BD-J application

The BD-ROM format supports Java for interactive functions. "BD-J" offers content providers almost unlimited functionality when creating interactive BD-ROM titles.

BD-R (pages 6, 26)

A BD-R (Blu-ray Disc Recordable) is a recordable, write-once Blu-ray Disc. Since contents can be recorded and cannot be overwritten, a BD-R can be used to archive data or for storing and distributing video material.

BD-RE (pages 6, 26)

A BD-RE (Blu-ray Disc Rewritable) is a recordable and rewritable Blu-ray Disc.

BD-ROM

BD-ROMs (Blu-ray Disc Read-Only Memory) are commercially produced discs. Other than conventional movie and video contents, these discs have enhanced features such as interactive content, menu operations using pop-up menus, selection of subtitle display, and slide shows. Although a BD-ROM may contain any form of data, most BD-ROM discs will contain movies in High Definition format for playback on Blu-ray Disc players.

Blu-ray Disc (BD) (page 6)

A disc format developed for recording/playing high-definition (HD) video (for HDTV, etc.), and for storing large amounts of data. A single layer Blu-ray Disc holds up to 25 GB, and a dual-layer Blu-ray Disc holds up to 50 GB of data.

Chapter number (page 32)

Sections of a movie or a music feature that are smaller than titles. A title is composed of several chapters. Some discs may only be comprised of a single chapter.

Copy guard

This function prevents copying. You cannot copy discs marked by the copyright holder with a signal which prevents copying.

Disc menu (page 25)

This lets you select things like the subtitle language or audio format using a menu stored on the DVD video disc.

Dolby Digital

A sound system developed by Dolby Laboratories Inc. that gives movie theatre ambience to audio output when the product is connected to a Dolby Digital processor or amplifier.

Dolby Digital Plus

A sound system developed as an extension to Dolby Digital, this audio coding technology supports 5.1 multi-channel surround sound.

Dolby TrueHD

Dolby TrueHD is a lossless coding technology that supports up to 8 channels of multi-channel surround sound for the next generation optical discs. The reproduced sound is true to the original source bit-for-bit.

DTS

This is a digital sound system developed by DTS, Inc. for use in cinemas. This system uses 6 audio channels and provides accurate sound field positioning and realistic acoustics. (By connecting a DTS Digital Surround decoder, you can also listen to DTS Digital Surround sound.)

DVD video (pages 6, 7, 24)

A disc format that contains up to eight hours of moving pictures on a disc the same diameter as a CD. A single-layer single sided DVD holds up to 4.7 GB; a double layer single-sided DVD, 8.5 GB; a single layer double-sided DVD, 9.4 GB; double-layer double-sided DVD, 17 GB. The MPEG 2 format was adopted for efficient video data compression. It is a variable rate technology that encodes the data to according to the status of the video for reproducing high-quality images. Audio information is recorded in a multi-channel format such as Dolby Digital, allowing for a realistic audio presence.

DVD+/-R (pages 6, 26)

A DVD+/-R is a recordable, write-once DVD. Since contents can be recorded and cannot be overwritten, a DVD+/-R can be used to archive data or for storing and distributing video material. The DVD+/-R has two different modes: VR mode and Video mode. DVDs created in Video mode have the same format as a DVD video, while discs created in VR (Video Recording) mode allow the contents to be programmed or edited.

DVD+/-RW (pages 6, 26)

A DVD+/-RW is a recordable and rewritable DVD. The re-recordable feature makes editing possible. The DVD+/-RW has two different modes: VR mode and Video mode. DVDs created in Video mode have the same format as a DVD video, while discs created in VR (Video Recording) mode allow the contents to be programmed or edited.

HDMI

HDMI (High-Definition Multimedia Interface) is an interface that supports both video and audio on a single digital connection. The HDMI connection carries standard to high definition video signals and multi-channel audio signals to AV components such as HDMI equipped TVs, in digital form without degradation.

Interlace format

Interlace format shows every other line of an image as a single "field" and is the standard method for displaying images on television. The even numbered field shows the even numbered lines of an image, and the odd numbered field shows the odd numbered lines of an image.

Letter Box (LB 4:3) (page 33)

A screen size with black bars on the top and bottom of the image to allow viewing of wide-screen (16:9) material on a connected 4:3 TV.

Linear PCM Sound

Linear PCM is a signal recording format used for Audio CDs and on some DVD and Blu-ray discs. The sound on Audio CDs is recorded at 44.1 kHz with 16 bits. (Sound is recorded between 48 kHz with 16 bits and 96 kHz with 24 bits on DVD video discs and between 48 kHz with 16 bits and 192 kHz with 24 bits on BD video discs.)

MPEG-2

MPEG-2 (Moving Picture Experts Group phase 2) is one of the video data compression schemes, which is adopted for DVD videos and digital broadcasts worldwide. Some Blu-ray Discs also use high bitrate MPEG-2.

Multi Angle (pages 30, 31)

This is a feature of DVD and BD video discs. In some discs, the same scene is shot from different angles, and these are stored in a single disc so you can enjoy playback from each angle. (This function can be enjoyed if the disc is recorded with multiple angles.)

Multi Audio

This is a feature of DVD and BD video discs. This function makes it possible to record different audio tracks for the same video, so you can enhance your enjoyment by switching the audio. (You can enjoy this function with discs recorded with multiple audio tracks.)

Pan Scan (PS 4:3) (page 33)

A screen size that cuts off the sides of the image to allow viewing of wide-screen (16:9) material on a connected 4:3 TV.

Parental control (page 41)

In some digital broadcasts and BD/DVD video discs, a control level for disc viewing is set depending on the age of the viewer. With this Player, you can set the control level for viewing such broadcasts and discs.

Pop-up menu (page 25)

An enhanced menu operation available on BD video discs. The pop-up menu appears when **POP-UP MENU** is pressed during playback, and can be operated while playback is in progress.

Progressive format

Compared to the Interlace format that alternately shows every other line of an image (field) to create one frame, the Progressive format shows the entire image at once as a single frame. This means that while the Interlace format can show 30 frames/60 fields in one second, the Progressive format can show 60 frames in one second. The overall picture quality increases and still images, text, and horizontal lines appear sharper.

Region code (page 6)

Code identifying a geographic region of compatibility for a BD/DVD.

Remote control code (page 21)

This is the type of the remote control signal for operating the Player. There are three types of remote control signals: "Remote Control No. 1" (RC-1), "Remote Control No. 2" (RC-2) and "Remote Control No. 3" (RC-3).

Resume playback (page 24)

If you stop playback while it is in progress, the Player stores the stop position in memory, and this function lets you playback from that point.

Skip (page 28)

This returns to the start of the chapter (or track) being played, or skips to the next chapter (or track).

Subtitles (pages 29, 31, 32)

These are the lines of text appearing at the bottom of the screen which translate or transcribe the dialogue. They are recorded on many DVD and BD video discs.

Time number

This indicates the play time which has elapsed from the start of a disc or a title. It can be used to find a specific scene quickly. (It may not work with some discs.)

Title number (pages 31, 32)

These numbers are recorded on DVD and Blu-ray discs. When a disc contains two or more movies, these movies are numbered as title 1, title 2, etc.

Top menu (page 25)

In a BD/DVD video, this is the menu for selecting things like the chapter to be played back and the subtitle language. In some DVD videos, the top menu may be called the "Title Menu".

Track number

These numbers are assigned to the tracks which are recorded on audio CDs. They enable specific tracks to be located quickly.

Specifications

General

Power supply	AC 120V, 60Hz
Power consumption (Normal)	25 W
Power consumption (Standby)	0.5 W (When "FRONT DISPLAY/LED" is set to "ON")
Dimensions	Approx. 16 ⁵⁹ / ₆₄ X 2 ¹¹ / ₁₆ X 13 ³ / ₁₆ inch (W x H x D)
Weight	Approx. 4.0 kg
Operating temperature	5°C to 35°C
Storage temperature	-20°C to 55°C
Operating humidity	10 % to 80 % (no condensation)
TV systems	NTSC system, 525 lines, 60 fields

Playback

Playable discs	BD-ROM, BD-RE (Ver. 2.1 1L), BD-R (Ver. 1.1 1L), DVD Video, DVD-R DL, DVD-RW/R, DVD+RW/R, Audio CD (CD-DA), CD-RW/R (CD-DA)
----------------	---

Input/Output

HDMI	HDMI 19-pin standard connector
Component video output	Output level: Y: 1 Vp-p (75 ohms) P _B /C _B , P _R /C _R : 0.7 Vp-p (75 ohms) Jacks: RCA jack
S-Video output	Y-Output level: 1 Vp-p (75 ohms) C-Output level: 0.3 Vp-p (75 ohms) Jack: 4 pin mini DIN
Video output	Output level: 1 Vp-p (75 ohms) Jack: RCA-pin jack
5.1 ch Audio output	Output level: 2 V rms (Output impedance: 1K ohms) Jacks: RCA jack
Digital audio optical output	Terminal: Square Optical terminal
Digital audio coaxial output	Jack: RCA jack
Audio output	Output level: 2 V rms (Output impedance: 1K ohms) Jacks: RCA jack

Specifications are subject to change without notice.

CONSUMER LIMITED WARRANTY

(Valid for warranty service in the U.S. and PUERTO RICO only)

CONSUMER LIMITED WARRANTY

SHARP ELECTRONICS CORPORATION warrants to the first consumer purchaser that this Sharp brand product (the "Product"), when shipped in its original container, will be free from defective workmanship and materials, and agrees that it will, at its option, either repair the defect or replace the defective Product or part thereof with a new or remanufactured equivalent at no charge to the purchaser for parts or labor for the period(s) set forth below.

This warranty does not apply to any appearance items of the Product or if the serial number or model number affixed to the Product has been removed, defaced, changed, altered or tampered with. This warranty does not cover installation or signal reception problems. This limited warranty will not apply if the Product has been or is being used in a commercial setting or application; this warranty is meant solely for the non-commercial, household use of the Product by consumers in their home or residence.

In order to enforce the rights under this limited warranty, the purchaser should follow the steps set forth below and provide proof of purchase to the servicer.

To the extent permitted by applicable state law, the warranties set forth are in lieu of, and exclusive of, all other warranties, express or implied. Specifically ALL OTHER WARRANTIES OTHER THAN THOSE SET FORTH ABOVE ARE EXCLUDED, ALL EXPRESS AND IMPLIED WARRANTIES INCLUDING THE WARRANTIES OF MERCHANTABILITY, FITNESS FOR USE, AND FITNESS FOR A PARTICULAR PURPOSE ARE SPECIFICALLY EXCLUDED. IF, UNDER APPLICABLE STATE LAW, IMPLIED WARRANTIES MAY NOT VALIDLY BE DISCLAIMED OR EXCLUDED, THE DURATION OF SUCH IMPLIED WARRANTIES IS LIMITED TO THE PERIOD(S) FROM THE DATE OF PURCHASE SET FORTH BELOW. THIS WARRANTY GIVES YOU SPECIFIC LEGAL RIGHTS. YOU MAY ALSO HAVE OTHER RIGHTS WHICH VARY FROM STATE TO STATE.

The warranties given herein shall be the sole and exclusive warranties granted by Sharp and shall be the sole and exclusive remedy available to the purchaser and only for the time periods set forth herein. No other representations or promises made by anyone are permitted. Correction of defects, in the manner and for the period of time described herein, shall constitute complete fulfillment of all liabilities and responsibilities of Sharp to the purchaser with respect to the Product, and shall constitute full satisfaction of all claims, whether based on contract, negligence, strict liability or otherwise. Sharp does not warrant nor shall Sharp be liable, or in any way responsible, for Products which have been subject to abuse (including, but not limited to, improper voltage), accident, misuse, negligence, lack of reasonable care, alteration, modification, tampering, improper operation or maintenance or any damages or defects in the Product which were caused by repairs or attempted repairs performed by anyone other than a Sharp authorized servicer. Nor shall Sharp be liable or in any way responsible for any incidental or consequential economic or property damage. Some states do not allow limits on warranties or on remedies for breach in certain transactions; in such states, the limits herein may not apply.

THIS LIMITED WARRANTY IS VALID ONLY IN THE FIFTY (50) UNITED STATES, THE DISTRICT OF COLUMBIA. AND PUERTO RICO

Model Specific Section

Your Product Model Number & Description:

BD-HP20U BLU-RAY DISC PLAYER

(Be sure to have this information available when you need service for your Product.)

Warranty Period for this Product:

One (1) year parts and labor from the date of purchase.

Additional Item(s) Excluded from Warranty Coverage (if any):

Non-rechargeable batteries.

Where to Obtain Service:

From a Sharp Authorized Servicer located in the United States. To find the location of the nearest Sharp Authorized Servicer, call Sharp toll free at 1-800-BE-SHARP.

What to do to Obtain Service:

Please transport the Product in its original packaging and ensure that the Product is covered to avoid scratches and damage. Sharp shall not be responsible for lost, stolen or misdirected mail or for damage to the product incurred during shipping.

TO OBTAIN PRODUCT INFORMATION, CALL 1-800-BE-SHARP OR VISIT www.sharpusa.com

SHARP®

LIMITED WARRANTY

Consumer Electronics Products

Congratulations on your purchase!

Sharp Electronics of Canada Ltd. (hereinafter called "Sharp") gives the following express warranty to the first consumer purchaser for this Sharp brand product, when shipped in its original container and sold or distributed in Canada by Sharp or by an Authorized Sharp Dealer:

Sharp warrants that this product is free, under normal use and maintenance, from any defects in material and workmanship. If any such defects should be found in this product within the applicable warranty period, Sharp shall, at its option, repair or replace the product as specified herein.

This warranty shall not apply to:

- (a) Any defects caused or repairs required as a result of abusive operation, negligence, accident, improper installation or inappropriate use as outlined in the owner's manual.
- (b) Any Sharp product tampered with, modified, adjusted or repaired by any party other than Sharp, Sharp's Authorized Service Centres or Sharp's Authorized Servicing Dealers.
- (c) Damage caused or repairs required as a result of the use with items not specified or approved by Sharp, including but not limited to head cleaning tapes and chemical cleaning agents.
- (d) Any replacement of accessories, glassware, consumable or peripheral items required through normal use of the product including but not limited to earphones, remote controls, AC adapters, batteries, temperature probe, stylus, trays, filters, belts, ribbons, cables and paper.
- (e) Any cosmetic damage to the surface or exterior that has been defaced or caused by normal wear and tear.
- (f) Any damage caused by external or environmental conditions, including but not limited to transmission line/power line voltage or liquid spillage.
- (g) Any product received without appropriate model, serial number and CSA/cUL markings.
- (h) Any products used for rental or commercial purposes.
- (i) Any installation, setup and/or programming charges.

Should this Sharp product fail to operate during the warranty period, warranty service may be obtained upon delivery of the Sharp product together with proof of purchase and a copy of this LIMITED WARRANTY statement to an Authorized Sharp Service Centre or an Authorized Sharp Servicing Dealer. In home warranty service may be provided at Sharp's discretion on any Sharp television with the screen size of 27" or larger and on any Sharp Over-the-Range Microwave Oven.

This warranty constitutes the entire express warranty granted by Sharp and no other dealer, service centre or their agent or employee is authorized to extend, enlarge or transfer this warranty on behalf of Sharp. To the extent the law permits, Sharp disclaims any and all liability for direct or indirect damages or losses or for any incidental, special or consequential damages or loss of profits resulting from a defect in material or workmanship relating to the product, including damages for the loss of time or use of this Sharp product or the loss of information. The purchaser will be responsible for any removal, reinstallation, transportation and insurance costs incurred. Correction of defects, in the manner and period of time described herein, constitute complete fulfillment of all obligations and responsibilities of Sharp to the purchaser with respect to the product and shall constitute full satisfaction of all claims, whether based on contract, negligence, strict liability or otherwise.

WARRANTY PERIODS:

	Parts & Labour (exceptions noted)
Audio Product	1 year
Camcorder	1 year
DVD Product	1 year
Projector	1 year (lamp 90 days)
LCD TV	1 year
Microwave Oven	1 year (magnetron component-4 additional years)
Air Purifier	1 year
Portable Air Conditioner	1 year

To obtain the name and address of the nearest Authorized Sharp Service Centre or Dealer, please contact:
SHARP ELECTRONICS OF CANADA LTD. 335 Britannia Road East, Mississauga, Ontario L4Z 1W9

For more information on this Warranty, Sharp Extended Warranty Offers, Sharp Canada Products, Accessory Sales, Dealer or Service Locations, please call (905) 568-7140
Visit our Web site: www.sharp.ca



SHARP®

SHARP ELECTRONICS CORPORATION

Sharp Plaza, Mahwah, New Jersey 07430-2135

SHARP CORPORATION

Printed in Malaysia
Imprimé en Malaisie
Impreso en Malasia

TINS-D348WJQZ ©
07P12-MA-NG